

# Hiding in Plain Signal: Physical Signal Overshadowing Attack on LTE

Hoon Yang, Sangwook Bae, Mincheol Son, Hongil Kim,  
Song Min Kim, and **Yongdae Kim**

USENIX Security 2019



22/12/01  
CheolJun Park

# People love this work. Why?

- New active attacker model in LTE
  - Have shown the feasibility of signal injection attack

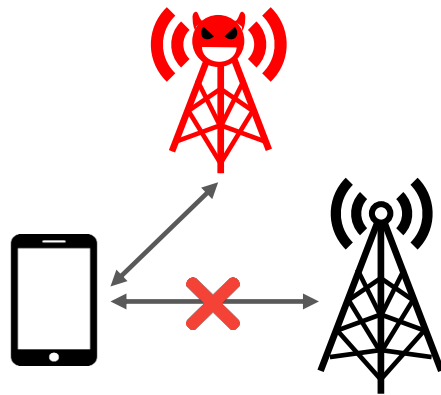

Fake Base Station

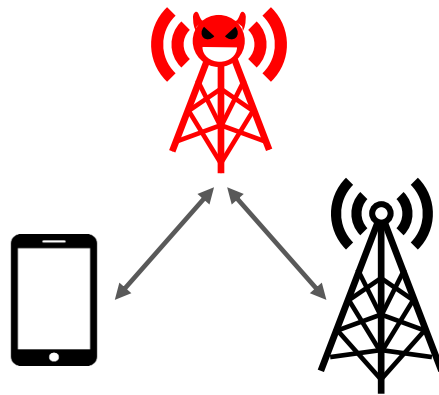

Man-in-the-Middle

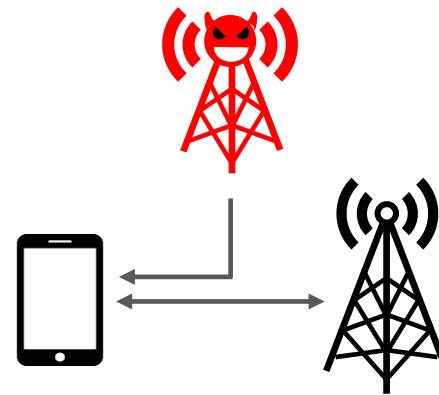

**Signal Injection**  
**(Man-on-the-side attack)**

# Overshadowing physical signal?

- Sounds easy
  - Strong physical signal
  - No security in the physical level
- Previous Targets
  - LR-WPAN (Low-Rate Wireless Personal Area Network) (802.15.4)
  - GPS
- None for cellular network
- However, there are technical challenges!
  - Reviewer: “I did not find it intuitive in the beginning that overshadowing attacks are likely to succeed in real-world LTE setups due to **tight dependencies on time and frequency synchronization**”

# LTE Architecture Overview

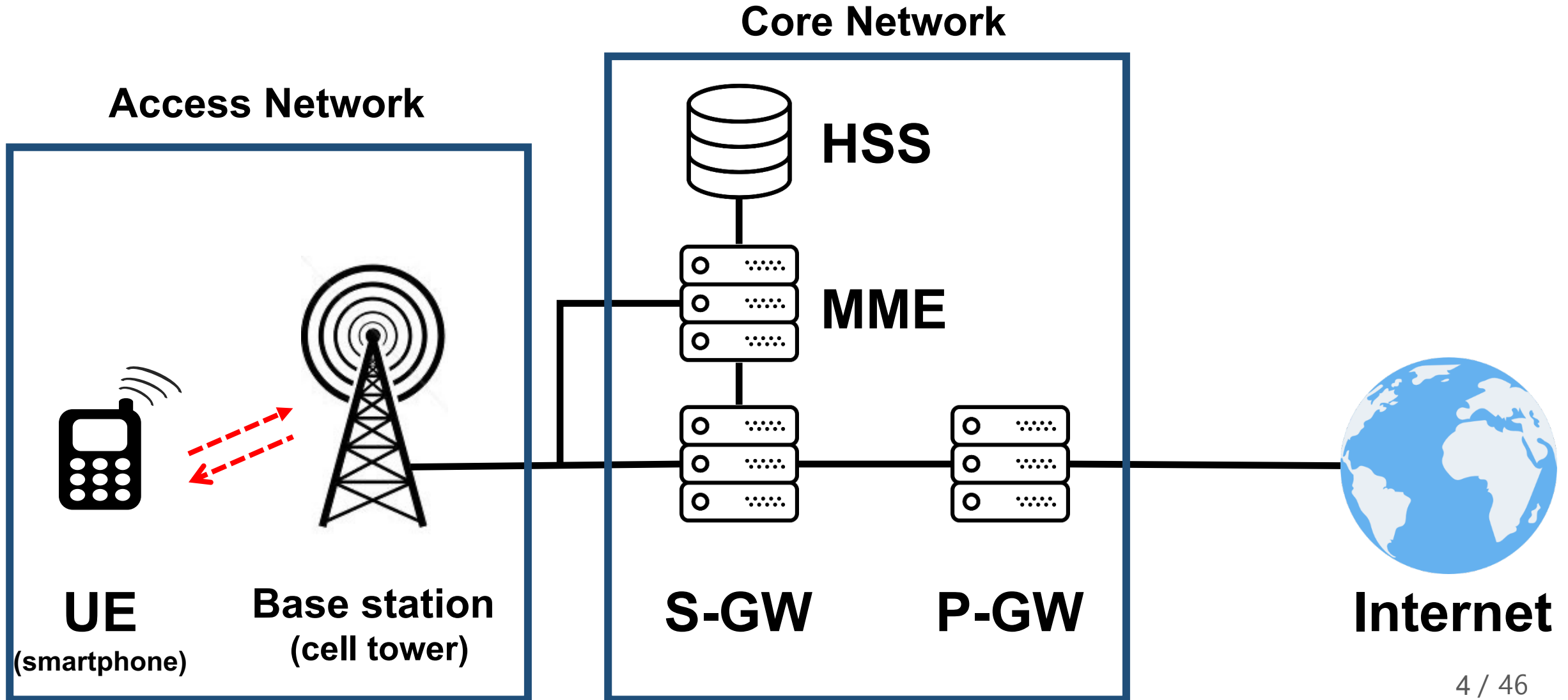

# LTE Architecture Overview

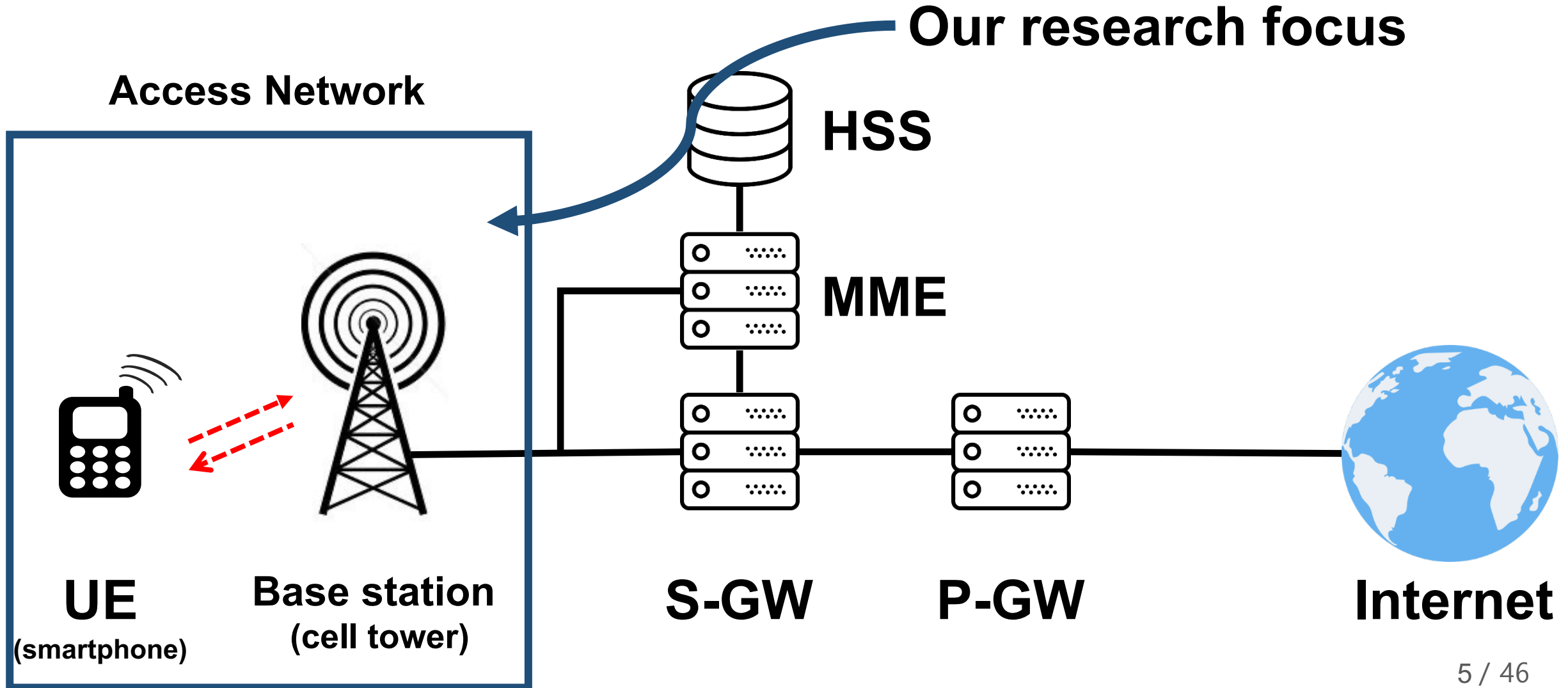

# LTE security

- Most LTE messages are integrity protected
  - **Only after** sharing security context
- Messages before sharing security context? **Not secure!**
- One of them is **broadcast messages**
  - Have never been integrity protected!
  - Thus, it is ***vulnerable***

# Broadcast Messages

- Terminology
  - Messages targeting multiple UEs within a cell at the same time
  - Not a formal Terminology though 😊
- Messages
  - Paging
  - System Information Block (SIB)
  - ...

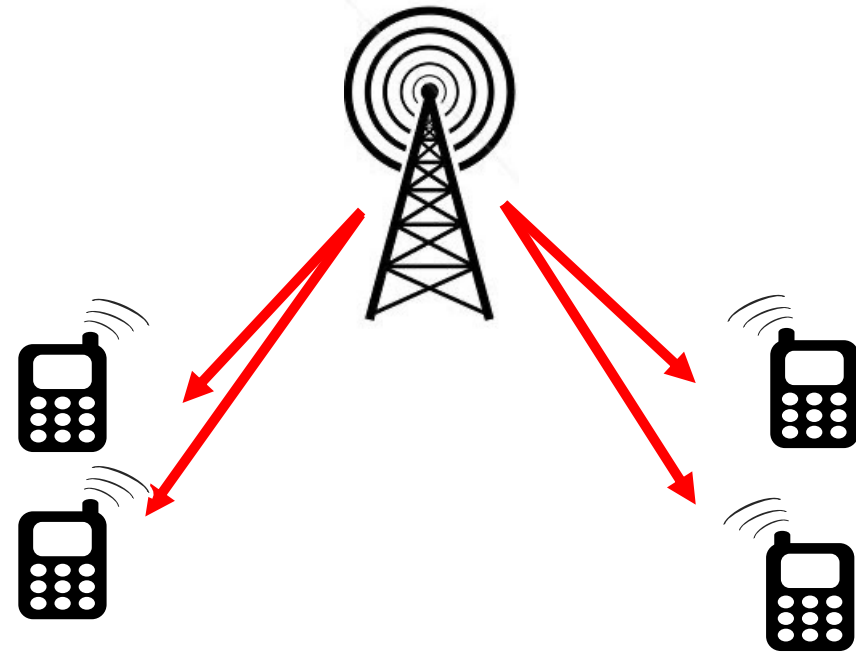

# Playing with Broadcast Messages

- How can an attacker send a *malicious* broadcast messages to the UE?

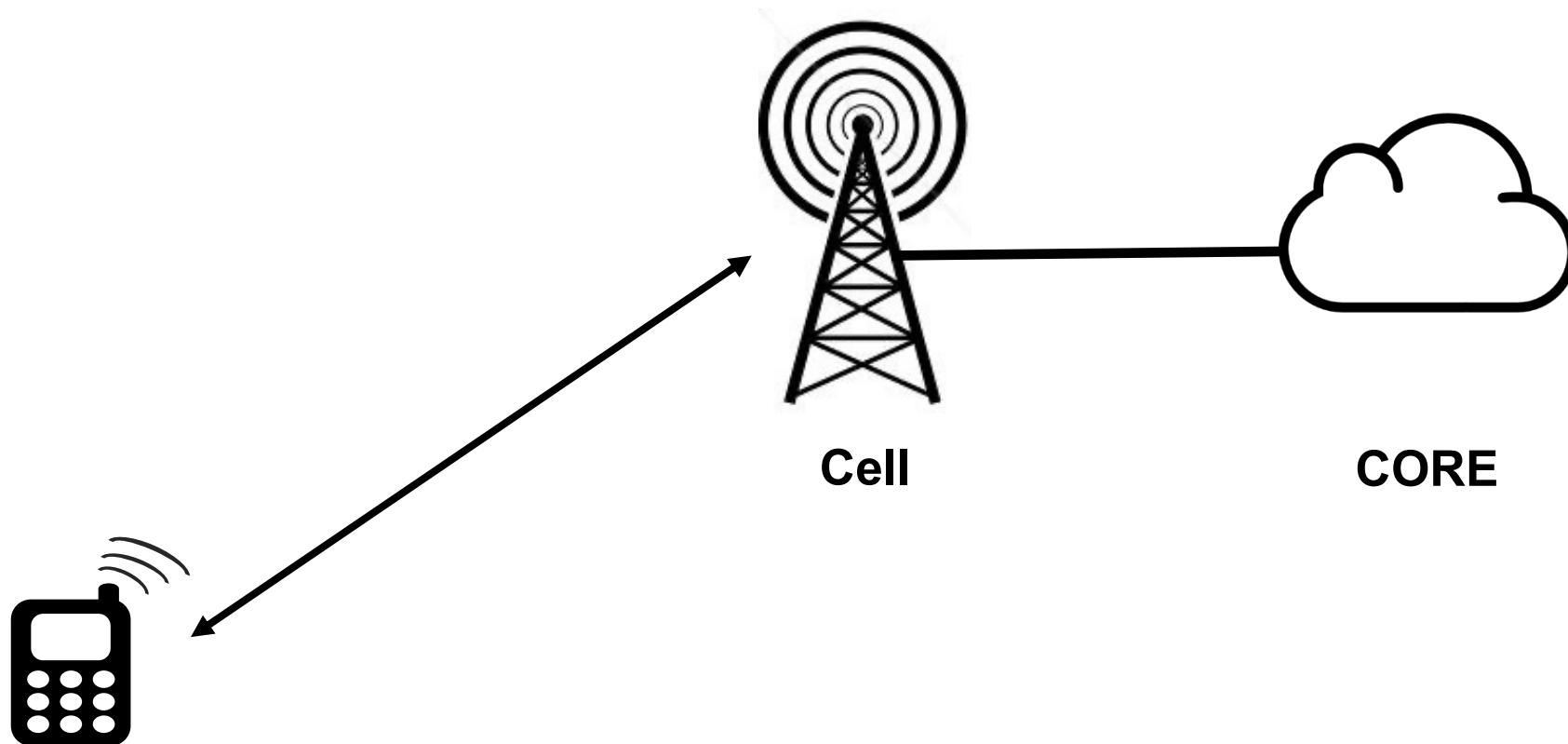



# Playing with Broadcast Messages

- Previously, the only way is to use fake base station (FBS)

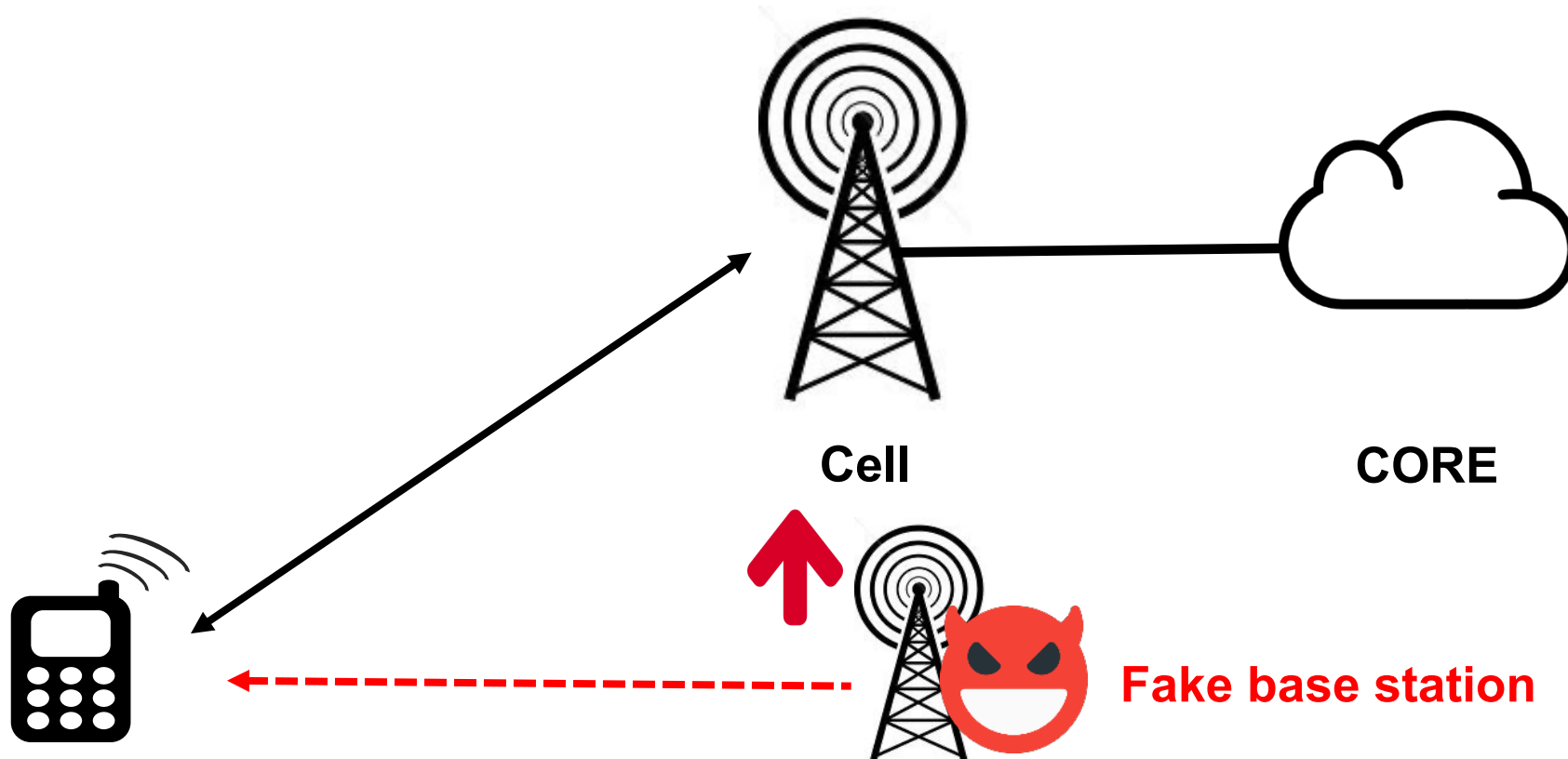

# Playing with Broadcast Messages

- Previously, the only way is to use fake base station (FBS)

Question:

Is REALLY FBS the only way? What else?

Answer:

Wireless signal can be manipulated through the air.



**Fake base station**

# Signal Overshadowing (SigOver)

- Exploiting fundamental weakness of the wireless comm.
  - Wireless signal can be counterfeited by intentional signal
- Transmit **time and frequency synchronized** signal

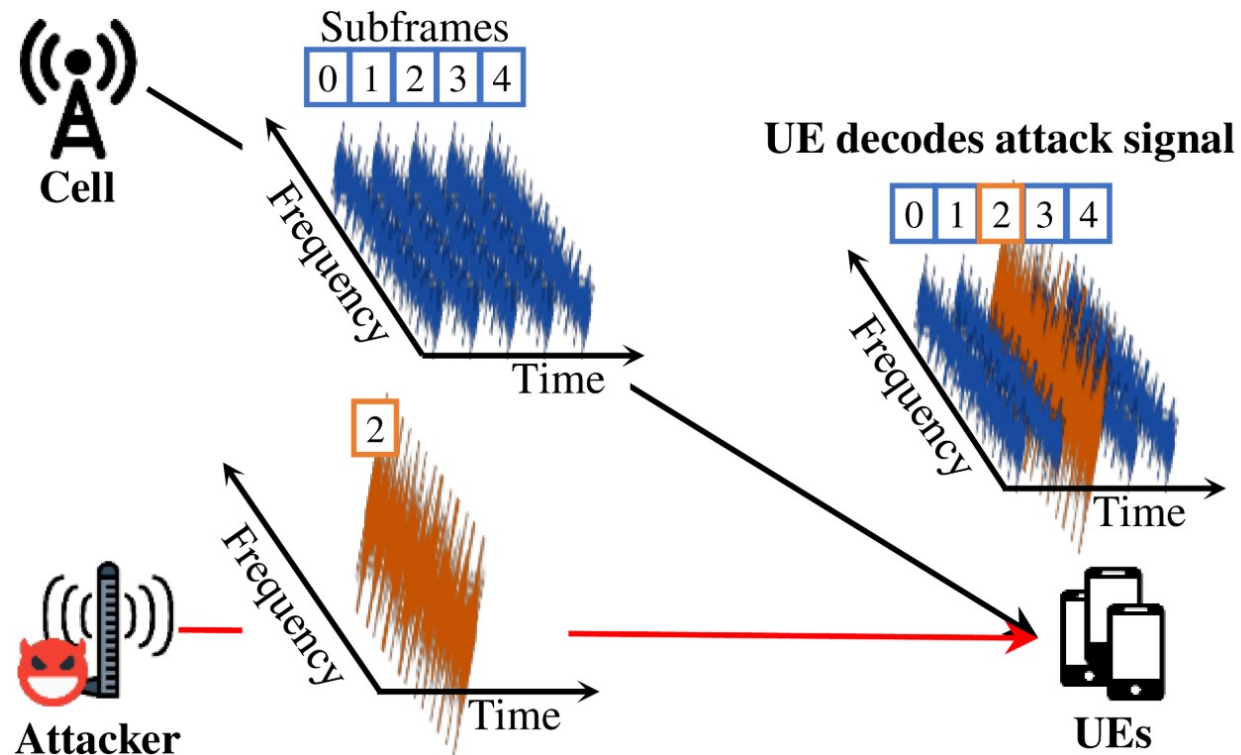

# Signal Overshadowing (SigOver)

- Exploiting fundamental weakness of the wireless comm.
  - Wireless signal can be counterfeited by intentional signal
- Transmit **time and frequency synchronized** signal



## Challenges and Questions:

1. Which part of the signal is overshadowed?
2. How to synchronize?
3. How much error is accepted?



# Attack Design

- Which part of the signal is overshadowed?
  - SigOver overshadows a **Subframe**
  - UE decodes the message in units of subframe

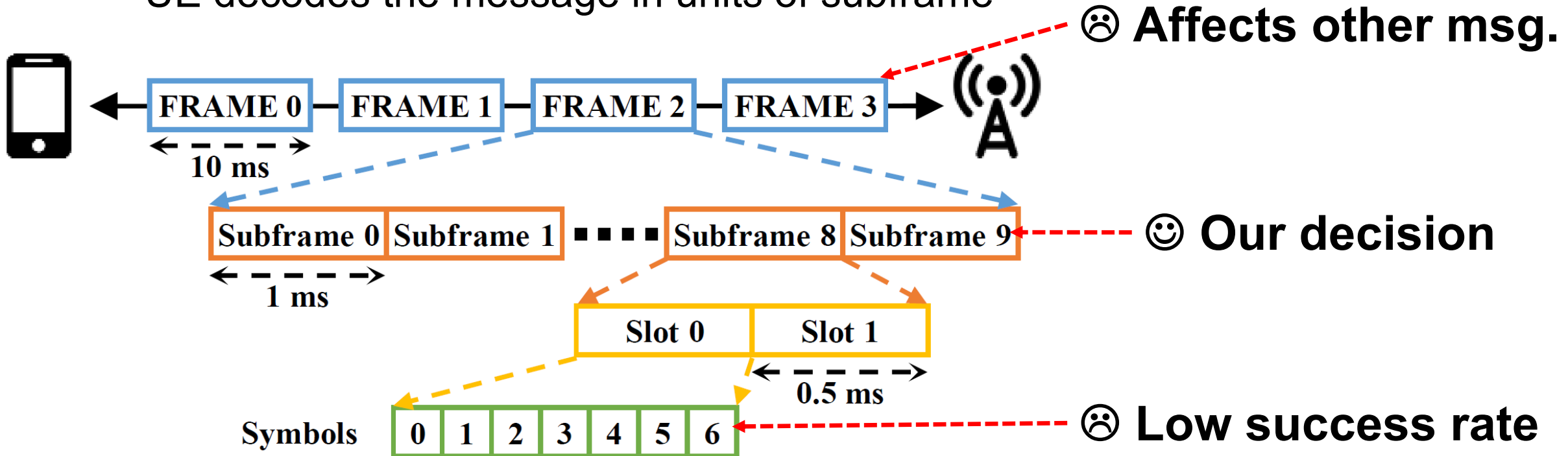

# Attack Design

- Crafted subframe
  - Pilot symbols
    - Pilot of the attacker will help the victim to decode the message properly
  - Malicious messages
    - Consists of various channel (PCFICH, PDCCH, PDSCH)

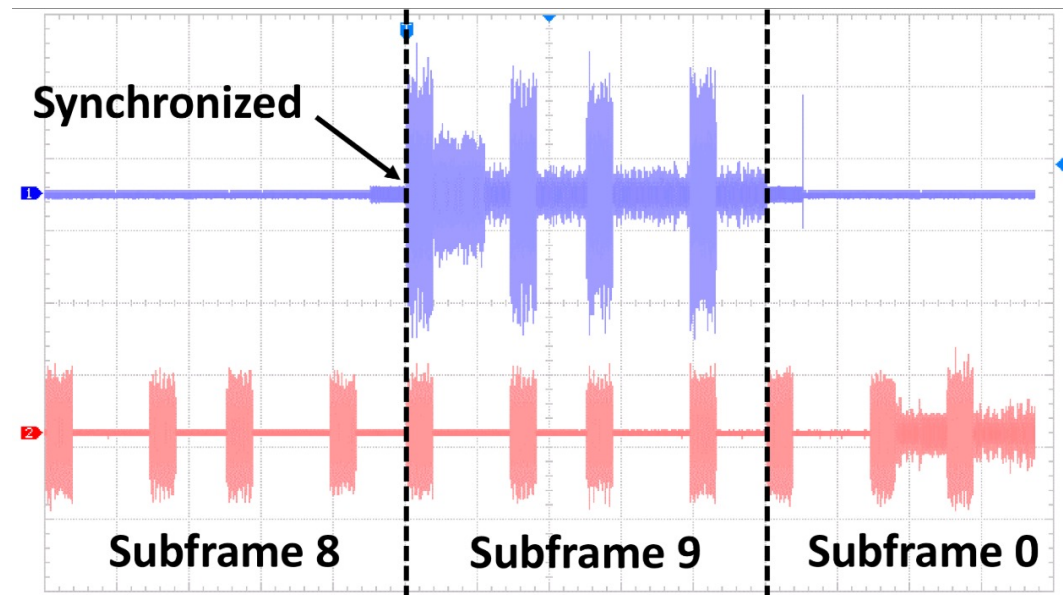

# Time Synchronization

- Attacker's subframe and legitimate subframe must arrive at the UE simultaneously
- For simplicity, let's assume there is no propagation delay

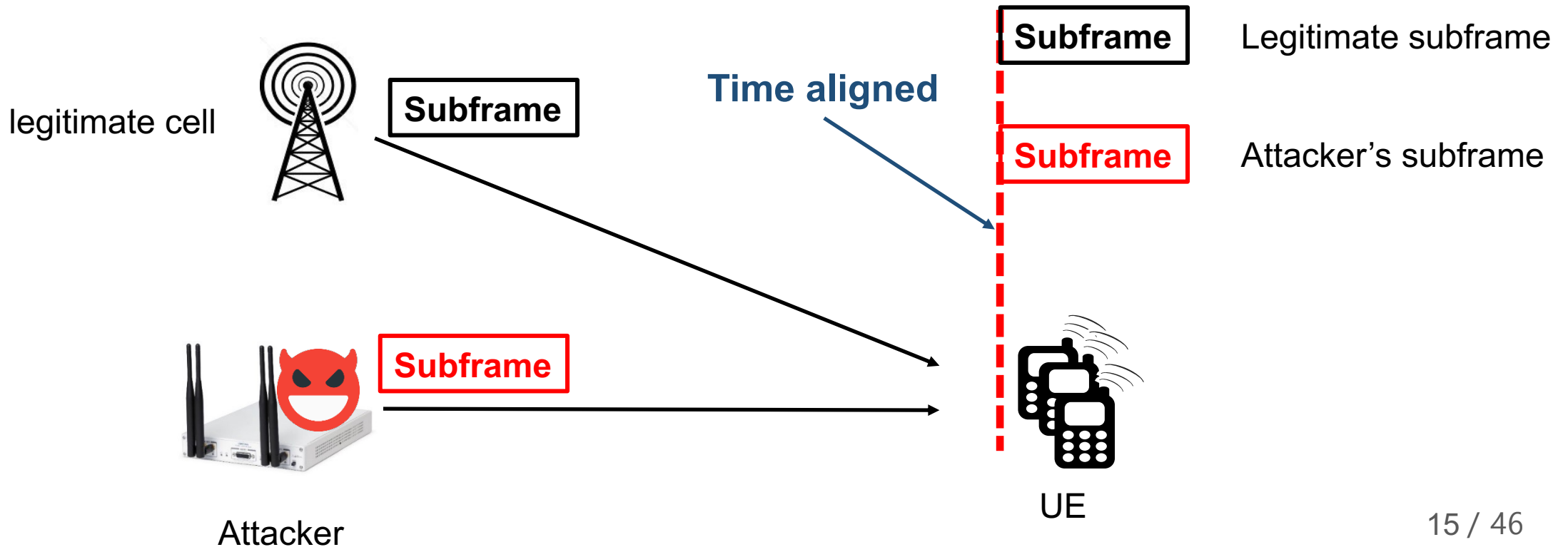

# Time Synchronization

- Use synchronization signal (PSS/SSS) of the legitimate cell
  - Locate frame timing of legitimate cell

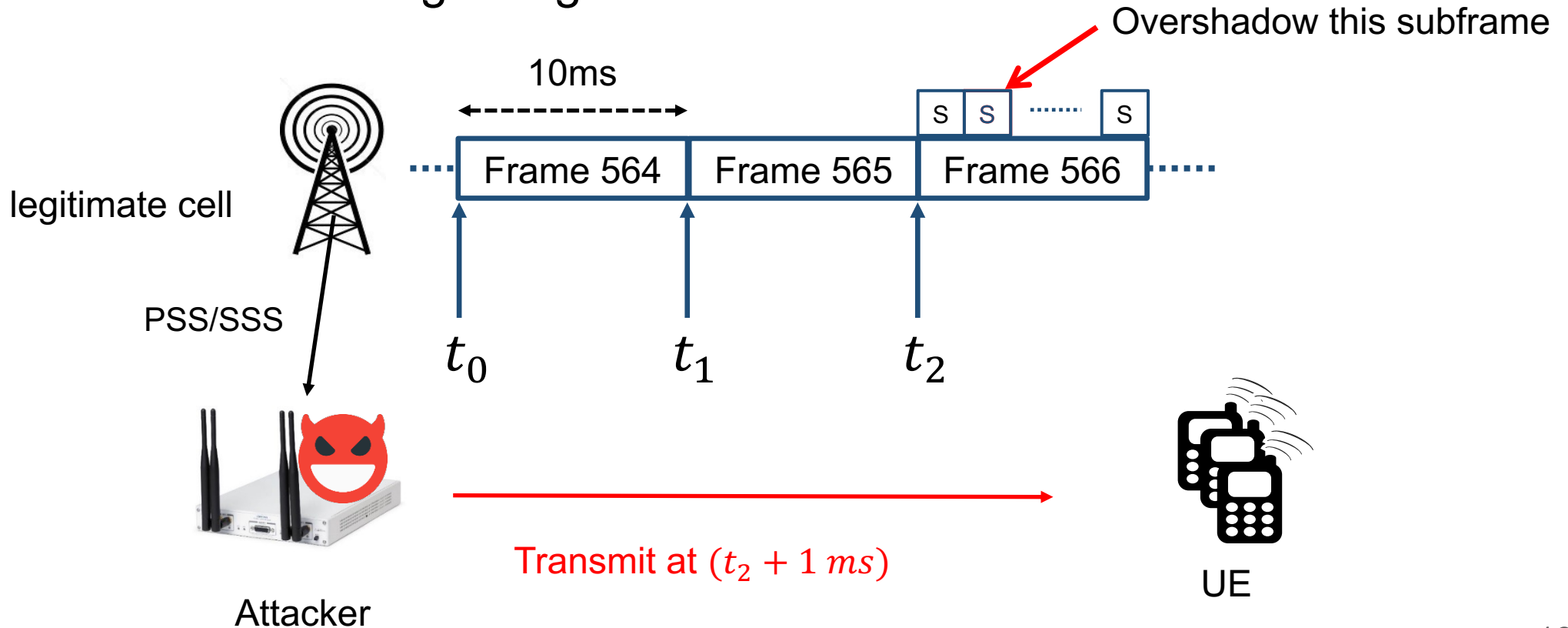



# Time Synchronization

- Relax our assumption
  - There is a propagation delay depending on the location

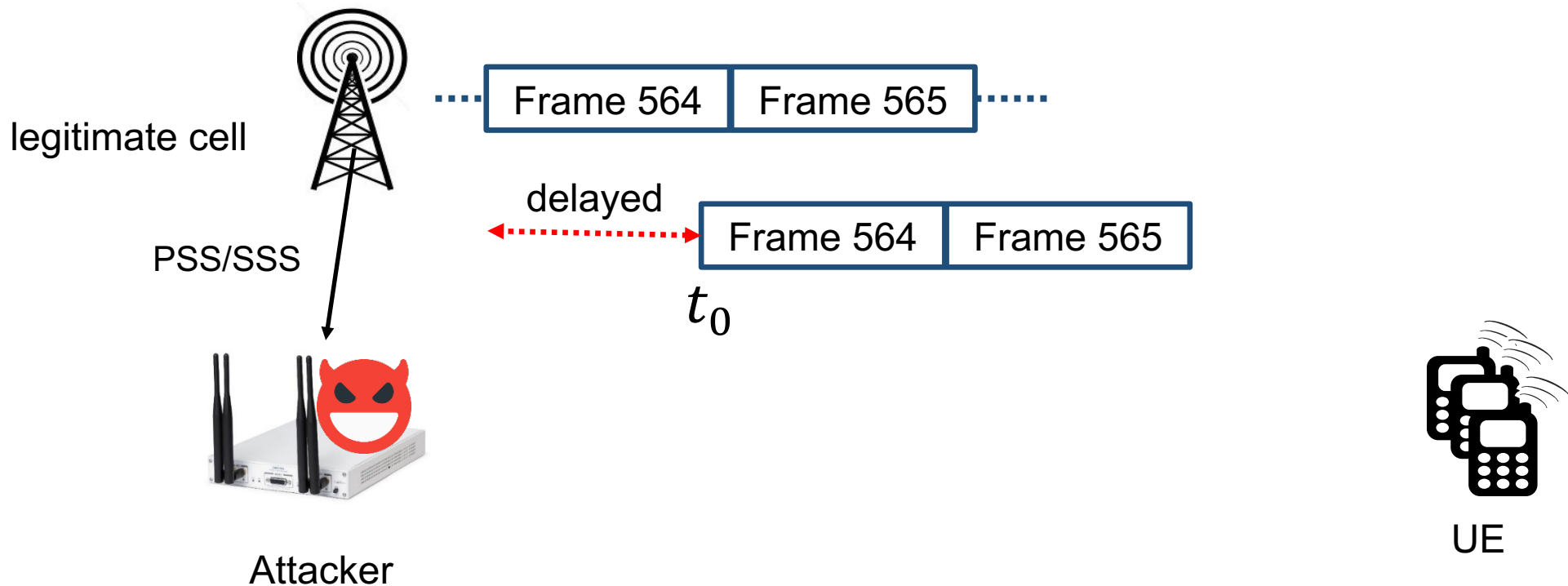

# Time Synchronization

- In the wild
  - There is an inevitable delay

Inevitable delay  
 $0 \leq d \leq \max\_d$

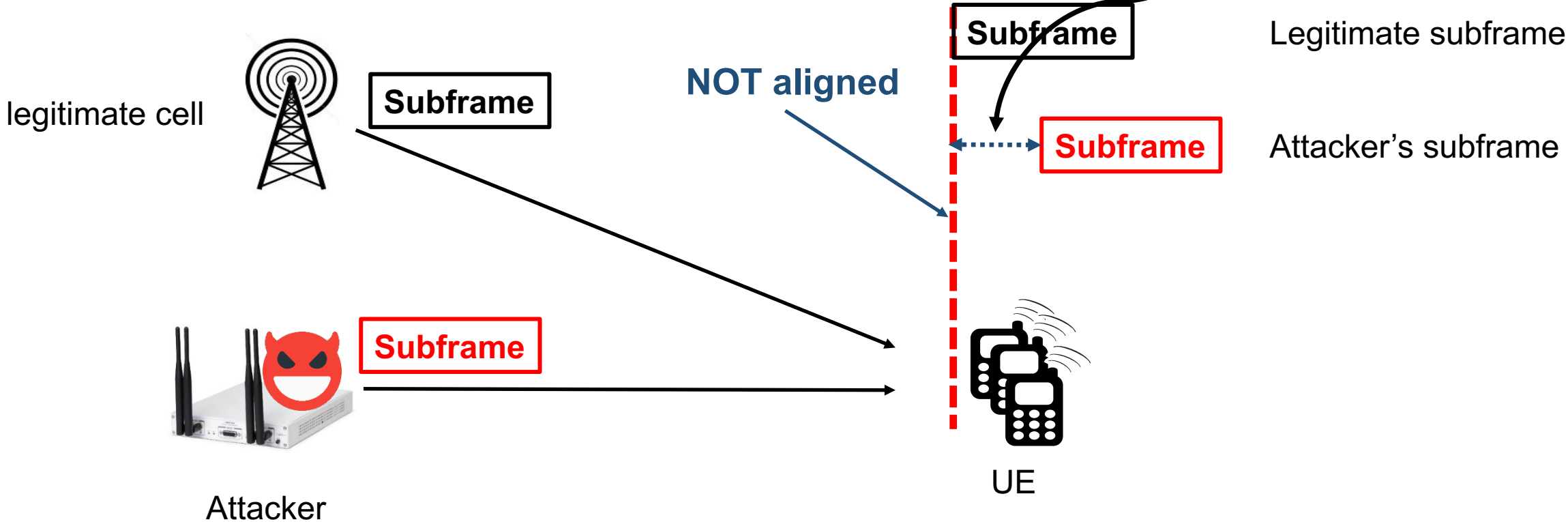

# Time Synchronization

- Count on the LTE UE
  - LTE is designed to be **reliable** especially in outdoor environment
  - We let the UEs compensate those **errors**
- Measuring time tolerance of COTS smartphones
  - Qualcomm
  - Exynos

Time ( $\mu s$ )	LG G7 (Qualcomm)	Galaxy S9 (Exynos)
Min.	-2.93	-2.60
Max.	9.77	8.46
Max. tolerance*	12.7	11.06

In urban cell,  
 $r = 1.5 \text{ km}$   
 $d \leq 8.66 \mu s$

# Frequency Synchronization

- Minimum frequency accuracy of legitimate cell
  - The standard defines minimum frequency accuracy of macro cell
  - 50 ppb ( $\pm 90 \text{ Hz @ } 1.8\text{GHz}$ )
- The attacker need at least 50 ppb frequency accuracy
- Residual frequency error be compensated by CFO correction

CFO: Center Frequency Offset

ppb: Parts Per Billion

# Frequency Synchronization

- Need at least 50 ppb frequency accuracy
  - SigOver was run on a typical, inexpensive SDR with an inaccurate oscillator (2000 ppb for USRP B210)
  - We adopt GPSDO
    - 25 ppb w/o GPS antenna
    - 1 ppb w/ GPS antenna
- Residual frequency error
  - We used PSS/SSS based CFO correction

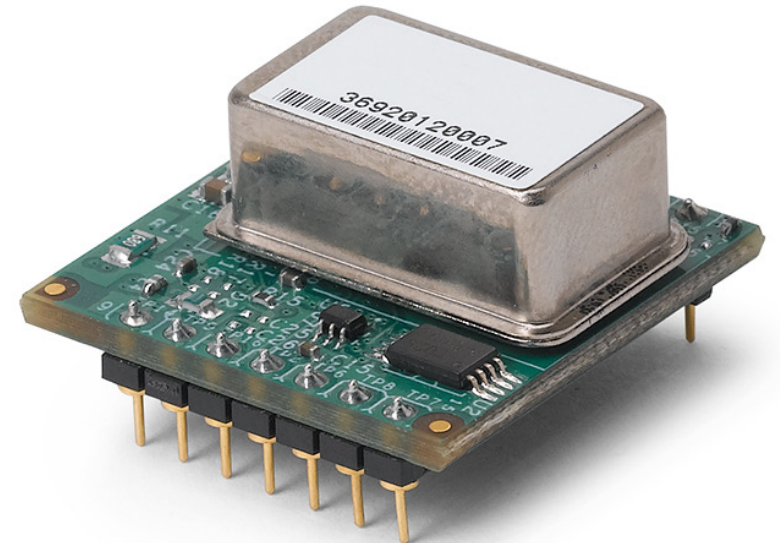

# Summary of Main Questions

- Which part of the signal is overshadowed?
  - Subframe
- How to synchronize?
  - PSS/SSS for time sync
  - GPSSDO and CFO correction for frequency sync
- How much error (time) is accepted?
  - Enough to cover the entire urban cell

# Test Environment

- Implementation
  - based on open source LTE stack (srsLTE)
- Attacker
  - USRP X310 + GPSDO (OCXO)
  - USRP B210 + GPSDO (TCXO)
- Victim devices
  - iPhone XS
  - iPhone 7
  - Galaxy S9
  - Galaxy S6 Edge
  - Galaxy S4
  - LG G6
  - LG G2
  - ...



# FBS vs. SigOver

- Both FBS and SigOver can inject malicious broadcast messages to the UEs
- No need to connection establishment

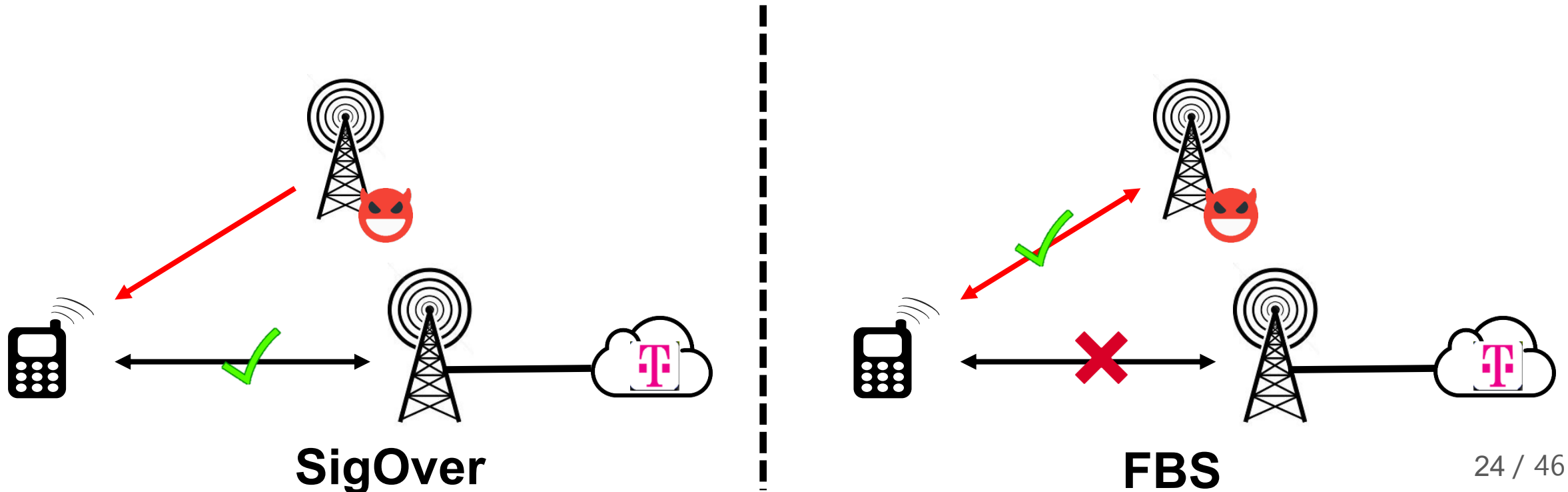



# Advantages

- Power efficient
  - Requires **+3 dB** power (success rate: 98%)
  - cf. Fake base station needs **+40 dB** (success rate: 100%)

Relative Power (dB)	1	3	5	7	9
SigOver	38%	98%	100%	100%	98%

Relative Power (dB)	25	30	35	40	45
FBS*	0%	0%	80%	100%	100%

\* Assume that the FBS sets the same freq. band, PCI, MIB and SIB1 to the legitimate cell

# Advantages

- UEs are keep communicating with the legitimate cell
  - UEs can receive or transmit all messages from/to legitimate cell
  - cf. UEs cannot communicate with legitimate cell during the fake base station attack

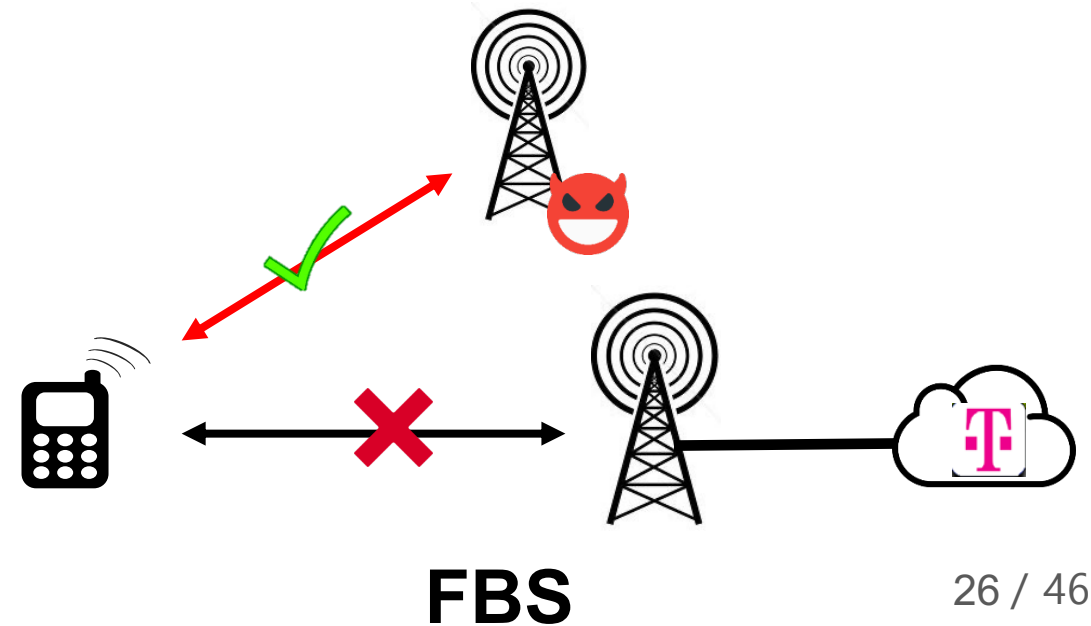
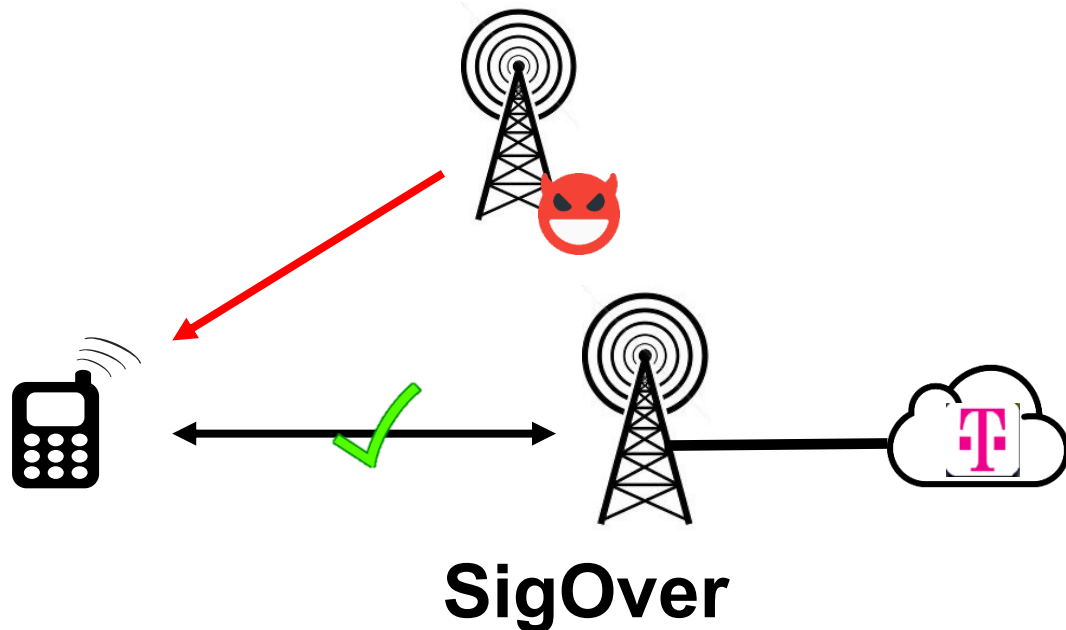

# Signaling Storm

- Using a botnet in general

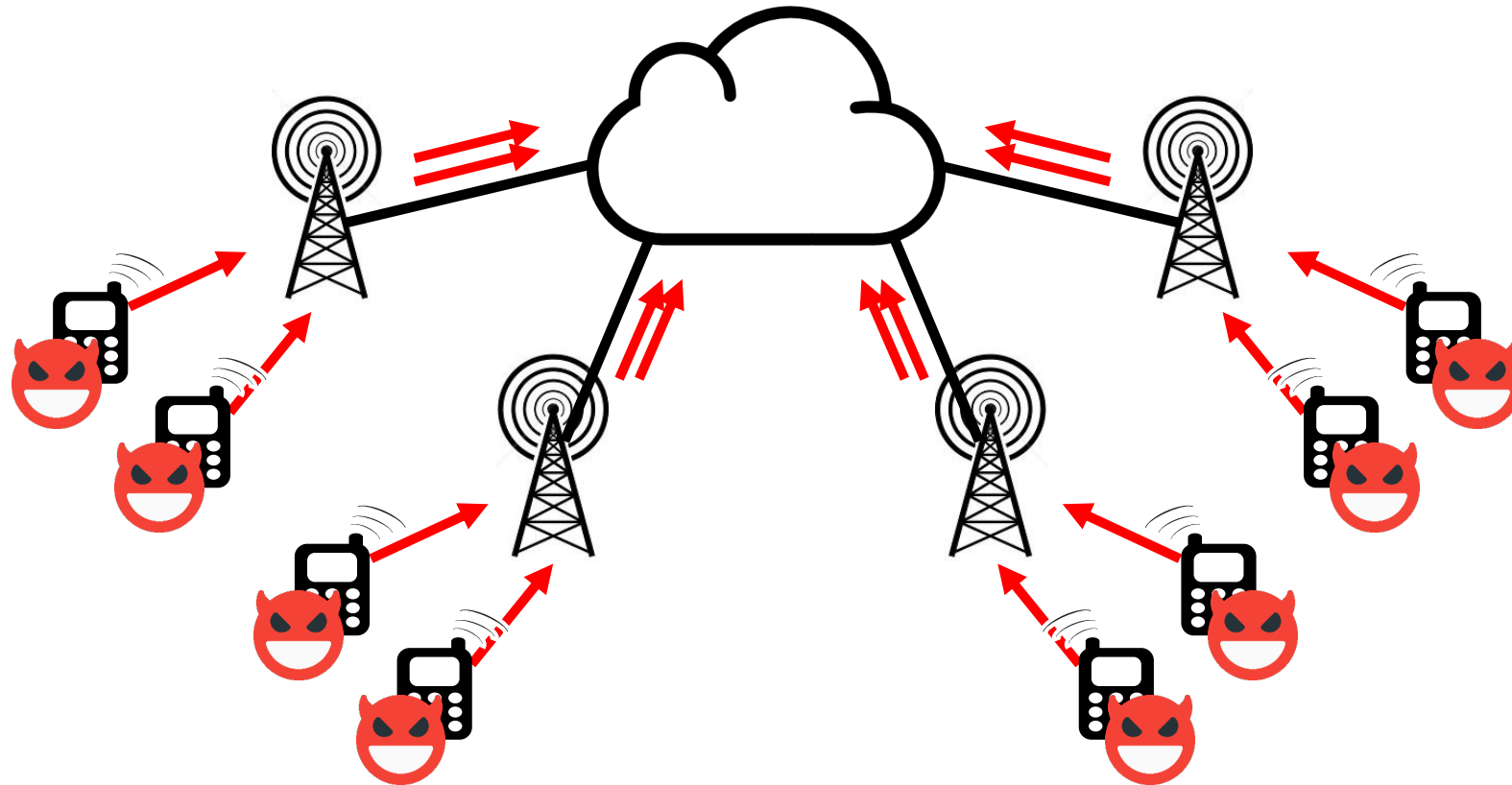

# Signaling Storm

## Using SigOver

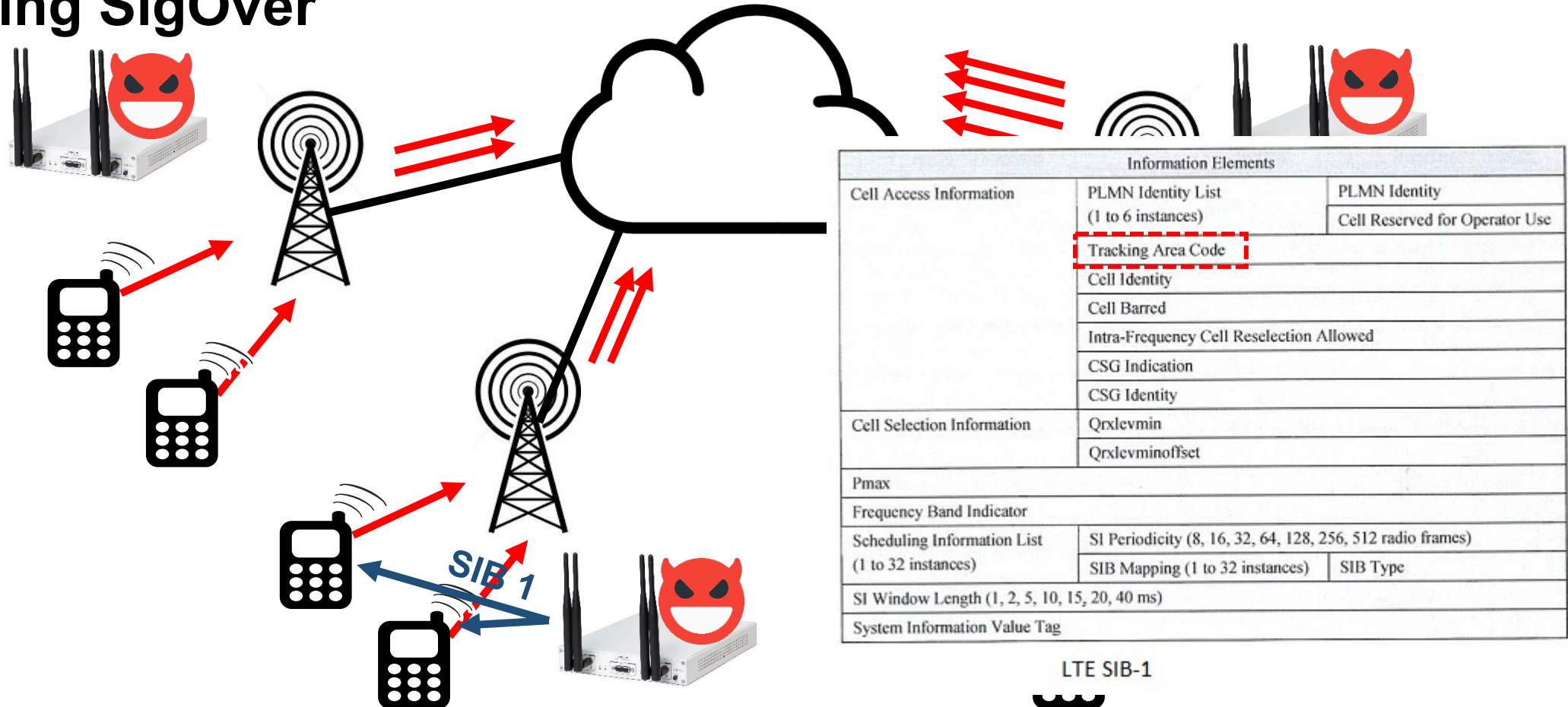

# Signaling Storm

Using fake base station

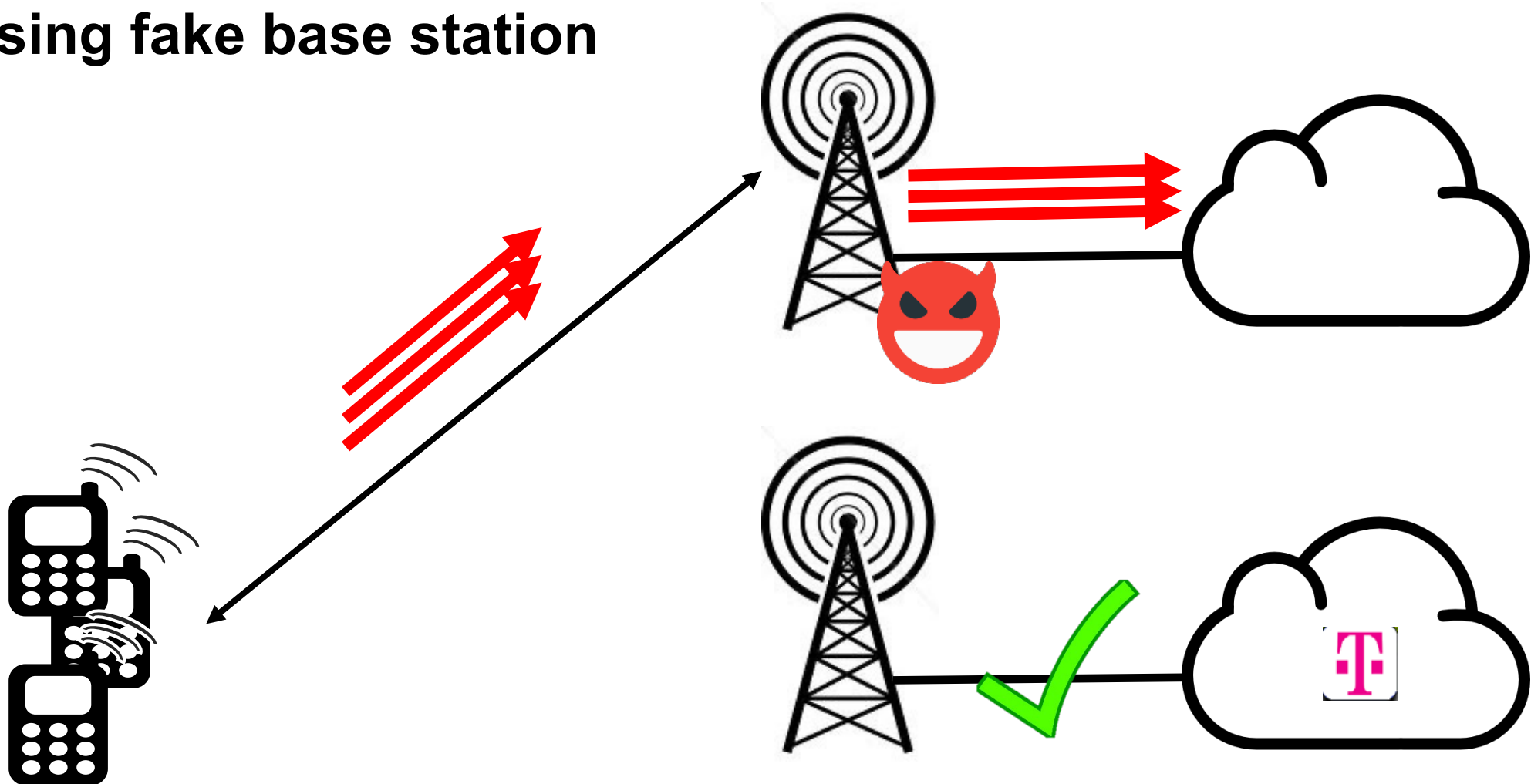

# Attack Efficiency

## Normal

- 45 service request per UE per hour in **peak busy hours** [1]

## SigOver

- ➔ • 21,600 TAU per UE per hour

### Note

Service request  $\cong$  15 messages  
TAU  $\cong$  20 messages

## Total number of Signaling Messages

- ➔ • Normal : 675 per UE per hour
- ➔ • SigOver : 432,000 per UE per hour (**640** times more than Normal)

# Signaling Storm Demo

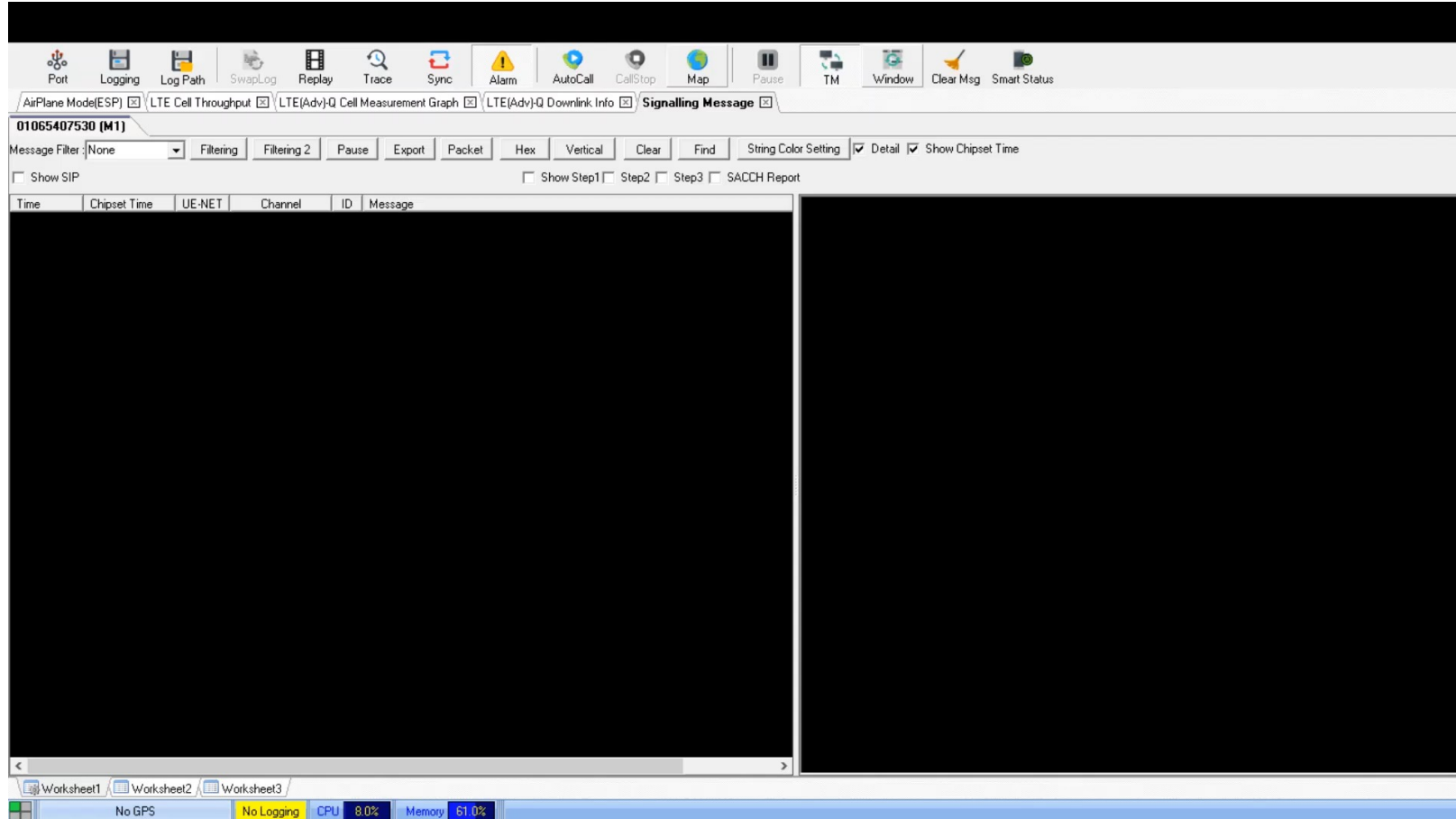

# Fake Emergency Alert Message





# For more videos...

- Please check our YouTube channel
  - SYSSEC KAIST

<https://www.youtube.com/channel/UCg1-TiATZj4qB0Xqknl18mA>

# Defense

- Detect it physically
  - Correlation

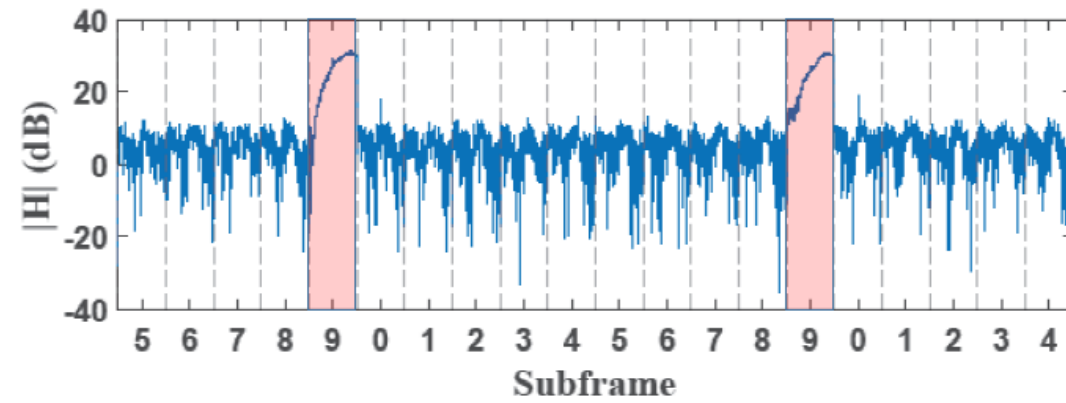

(a) LOS setup

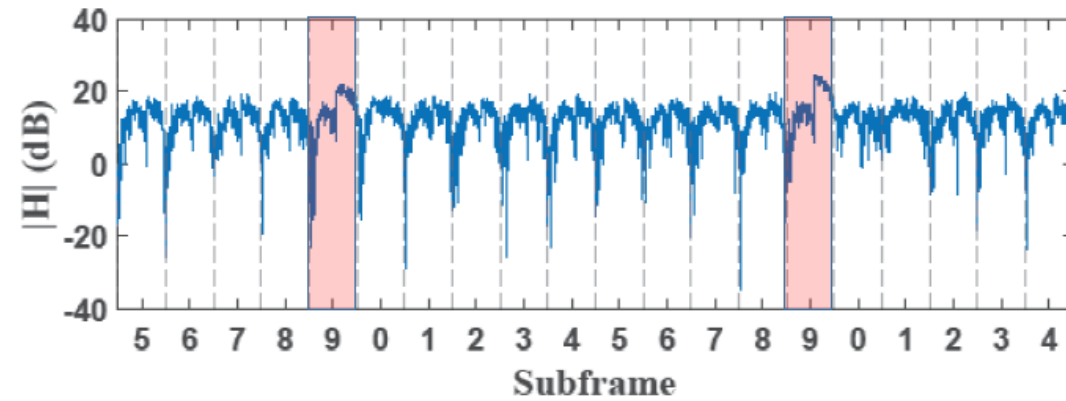

(b) NLOS setup

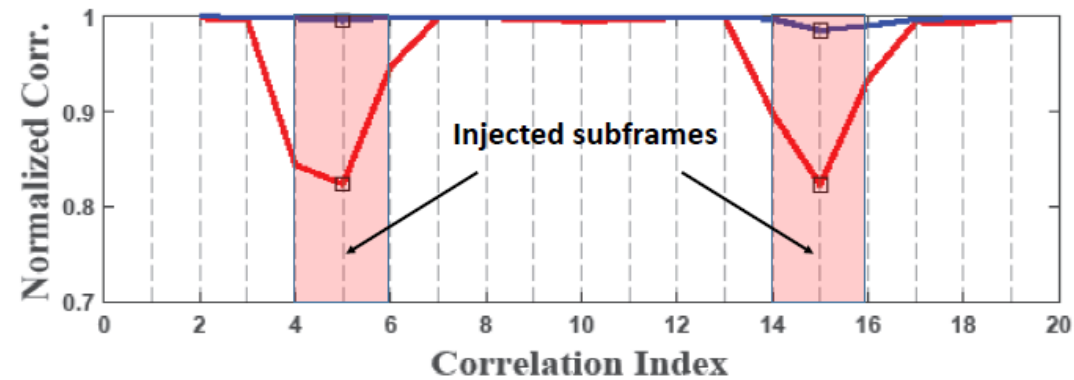

Blue line: NLOS

Red line: LOS

# Defense

- Integrity protection on broadcast messages
- In 5G, operator's public key will be provisioned on the USIM
  - In theory, Integrity protection is feasible
  - But, 3GPP does not considering it for now



# Conclusion

- SigOver attack
  - A new exploit on unpatched vulnerabilities in broadcast channel
  - Cheaper, stealthier than attacks using FBS
  - Found new attacks on broadcast messages
  - Expect to be used in the wild
- 3GPP to use digital signature despite key management issue

# Conclusion

- SigOver attack
  - A new exploit on unpatched vulnerabilities in broadcast channel
  - Cheaper, stealthier than attacks using FBS
  - Found new attacks on broadcast messages
  - Expect to be used in the wild
- 3GPP to use digital signature despite key management issue
- Responsible disclosure
  - GSMA: no practical implication 😊
  - Qualcomm: acknowledged

# SigOver in 5G

- Will SigOver Work in 5G?
  - “Yes” for now
  - Current Non-standalone design → Definitely “Yes”
    - 5G NSA uses the SAME Control plane messages in LTE
  - Standalone design? → “Partially Yes” (*Unless PKI is adopted*)
    - 5G SA uses the configurable frame structure (PHY signal)
    - Subframe is sent every 1 msec
  - Hardware issues
    - USRP supports up to 6 GHz
    - 5G SA supports up over 28 GHz

# After then?

- SigOver + alpha : Signal overshadowing attack on LTE and its applications (The 36<sup>th</sup> Chaos Communication Congress, 2019)
- AdaptOver: Adaptive Overshadowing of LTE signals (submitted to USENIX Security '22, arXiv)
- Data-Plane Signaling in Cellular IoT: Attacks and Defense (MobiCom 2021)

# After then?

- SigOver + alpha : Signal overshadowing attack on LTE and its applications (The 36<sup>th</sup> Chaos Communication Congress)
  - Inject **unicast message** with SigOver to force victim to attach to FBS

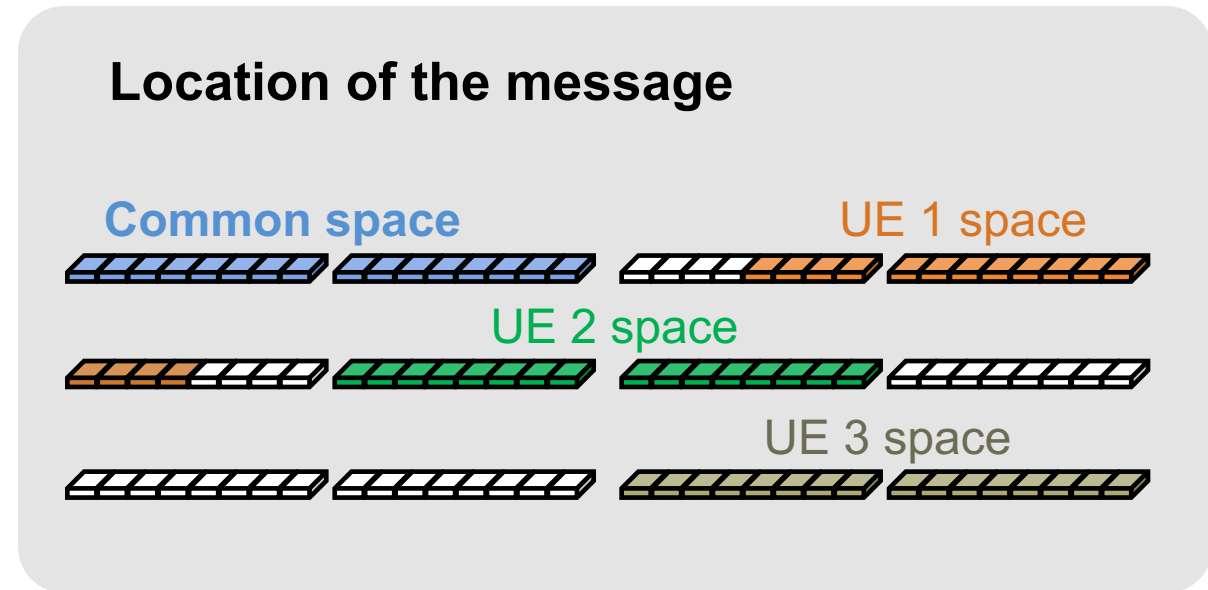
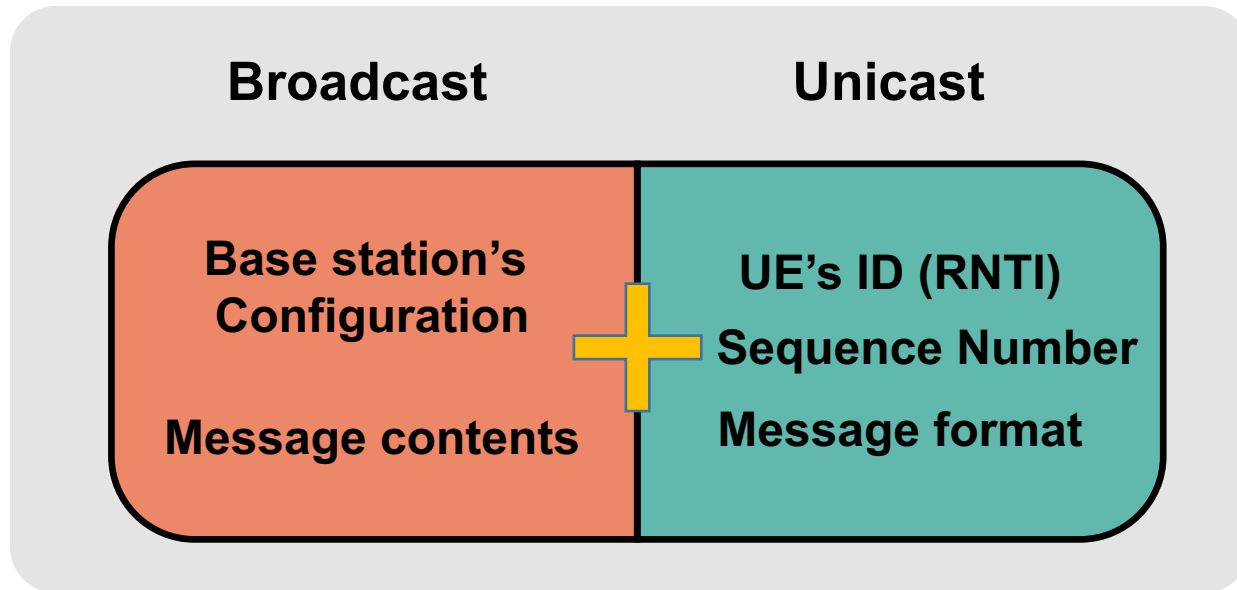

RNTI : Radio Network Temporary Identifier



# SigOver + Alpha

- Brief overview of the attack
  - Inject plain RRC message before security activation

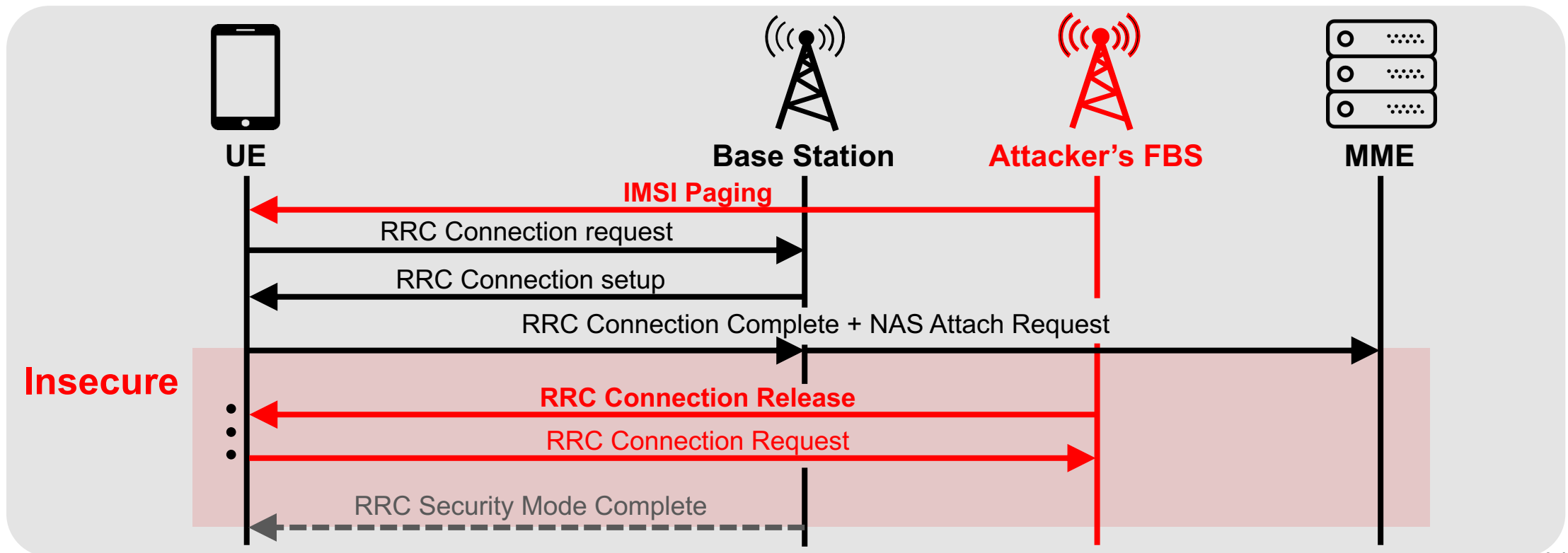

# After then?

- AdaptOver: Adaptive Overshadowing of LTE signals (submitted to USENIX Security '22, arXiv)
  - Inject **unicast NAS message** with SigOver to 12h DoS and IMSI catching

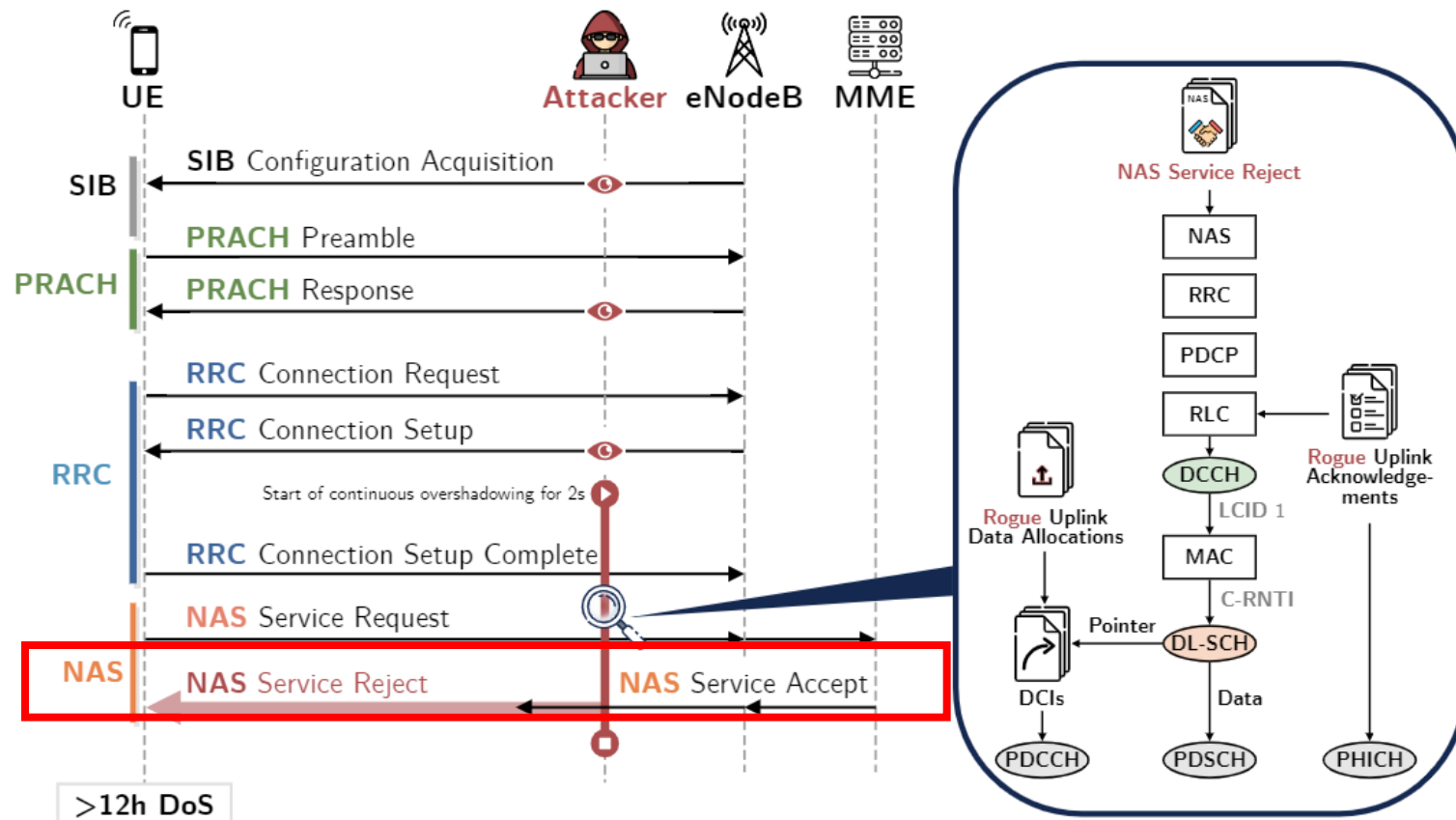

# AdaptOver

- Authentication Reject Attack
- IMSI Catching Attack

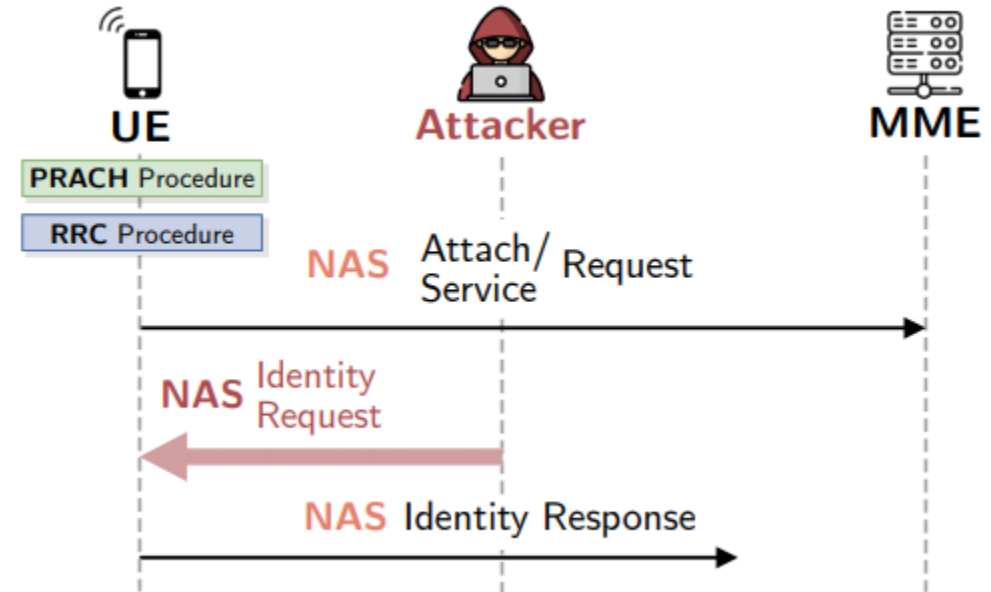
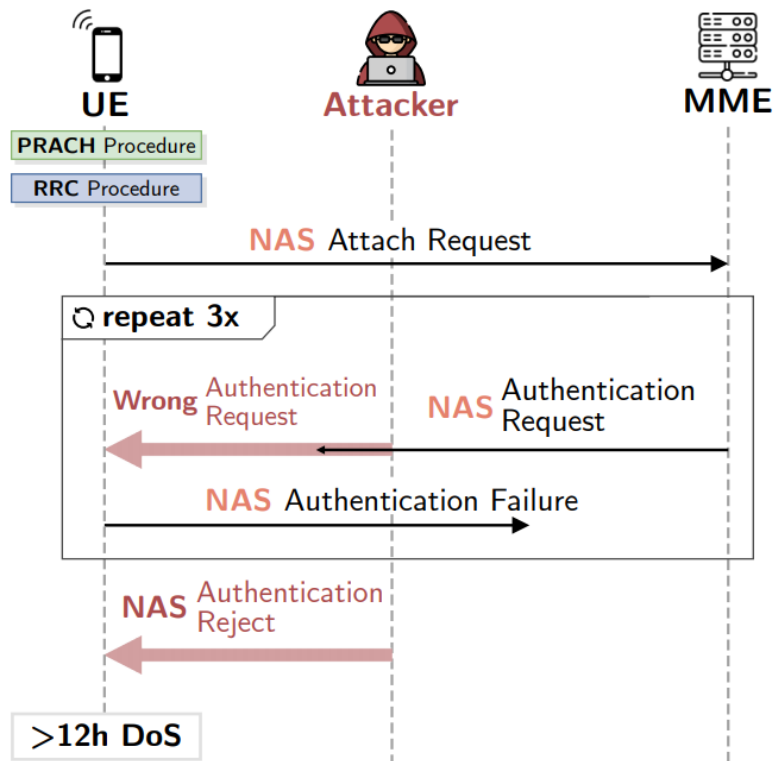

# After then?

- Data-Plane Signaling in Cellular IoT: Attacks and Defense (MobiCom 2021)
  - Inject unicast MAC CE message with SigOver for various attacks

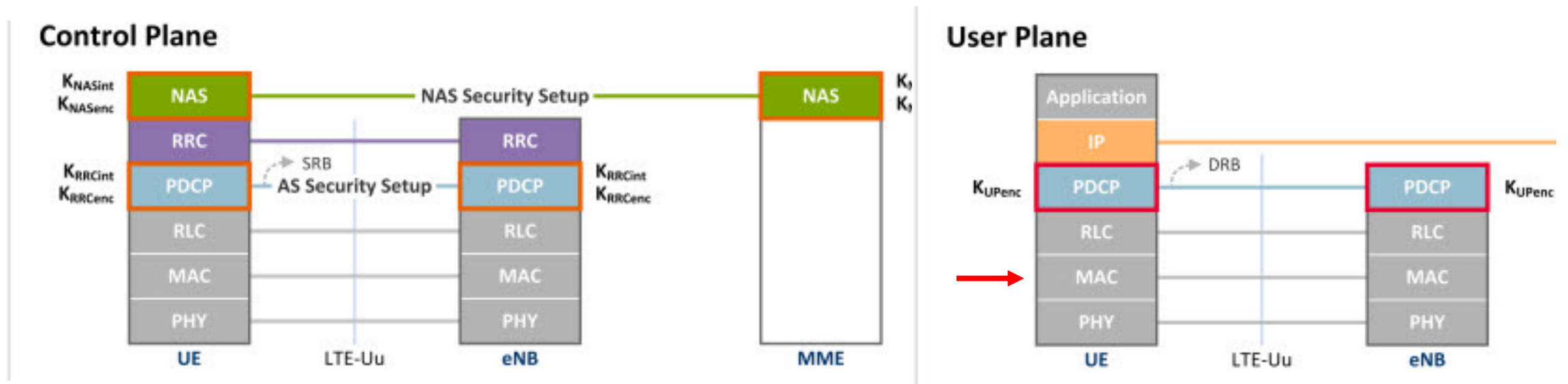

# Action of 3GPP

- Adopting PKI for Broadcast Messages have several challenges
- Deployment challenge @ *ISP*
  - Need to handle various events in the wild
    - Roaming, handover, MVNO, etc.
    - Transmitting *Warning Messages* to unsubscribed devices
  - Managing certificate
    - Establish Chain of trust, set up new eco system for managing the certificate
    - Maintain revocation list
- Technical challenge @ *base station & UE*
  - Verifying certificate & signature require additional **power consumption**

# Good questions

1. Will time synchronization work when there are multiple device around the victim and the attacker? Is it able to receive PSS/SSS and MIB from victim only and update the synchronization information on time? (JIN ZHIXIAN)
2. Is it not possible to detect message alterations based on the arrival time of signals? (이형주)
3. Will SigOver Work in 5G? (김호빈, 오지오, Valentin)

# Best questions

1. Researchers proposed that digital signing can be a mitigation for this attack. At the same time, they mentioned that applying an integrity protection mechanism can be challenging due to overhead and power consumption. Is introducing digital signing for messages (or other integrity protection mechanisms) a realistic and applicable solution for the attack? (허현)
2. Sigover attack is possible because the broadcast message is not security-protected. Then, is SigOver attack not possible for non-security protected unicast messages? (배한성)
3. What is the power and distance requirement for the attacker? (What should the attacker consider in this environment and will the success rate of the attack be significantly reduced?) (박승민)

**THANK YOU.  
ANY QUESTIONS?**



# BACKUP

# Will SigOver Work in 5G?

- We believe “Yes” for now
- Current Non-standalone design → Definitely “Yes”
  - 5G NSA uses the SAME Control plane messages in LTE
- Standalone design? → “Partially Yes” (*Unless PKI is adopted*)
  - 5G SA uses the SAME (and similar) frame structure
  - Subframe is sent every 1 msec
- Hardware issues
  - USRP supports up to 6 GHz
  - 5G SA supports up over 28 GHz

# What Can We Do More with SigOver?

- We can launch various attacks on UE and Network!
- By SigOver on *broadcast message*,
  - **SIB**: Signaling storm, fake emergency alert, selective DoS
  - **Paging**: DoS attack, network downgrading attack, location tracking
- Can an attacker use SigOver to send *uplink/downlink* messages?
  - Sure! (If the message is not integrity-protected)
- Maybe used to attach UE to FBS (not verified)
  
- BTW, why do we focus on the broadcast messages?
  - Located at the fixed position by 3GPP, effective attack vector

# LTE Resource Grid

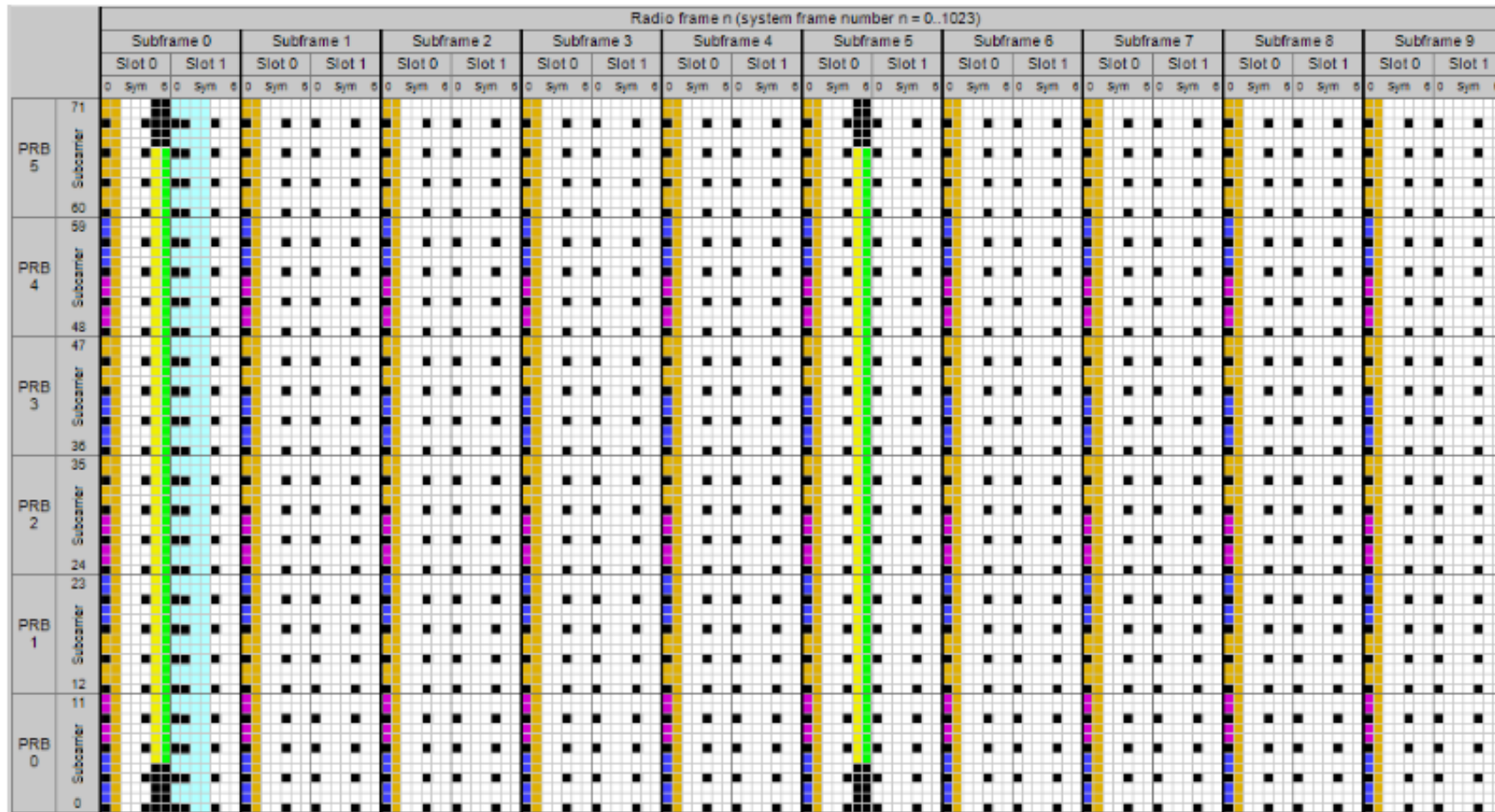

- PSCH (Primary Synchronization Channel)
- SSCH (Secondary Synchronization Channel)
- PBCH (Physical Broadcast Channel)
- RS (cell-specific Reference Signal) for selected Tx antenna port
- PCFICH (Physical Control Format Indicator Channel)
- PHICH (Physical Hybrid ARQ (Automatic Repeat reQuest) Indicator Channel)
- PDCCH (Physical Downlink Control Channel)
- Available for PDSCH (Physical Downlink Shared Channel)

# Comparison over MitM & FBS

	<b>Stealthiness</b>	<b>Power Efficiency</b>	<b>Attack sustainability</b>
FBS	Low	Low	Low
MiTM	Limited	Low	Limited
SigOver	High	High	High

# Previous study

- Previous Targets
  - LR-WPAN (802.15.4)
  - GPS
- None for 2G/3G/4G
  - Reviewer 1
    - “I did not find it intuitive in the beginning that overshadowing attacks are likely to succeed in real-world LTE setups due to tight dependencies on time and frequency synchronization”

# SigOver + Alpha

- 1 : Victim is connected to the legitimate network and has security context
  - **SigOver IMSI paging** to delete the security context

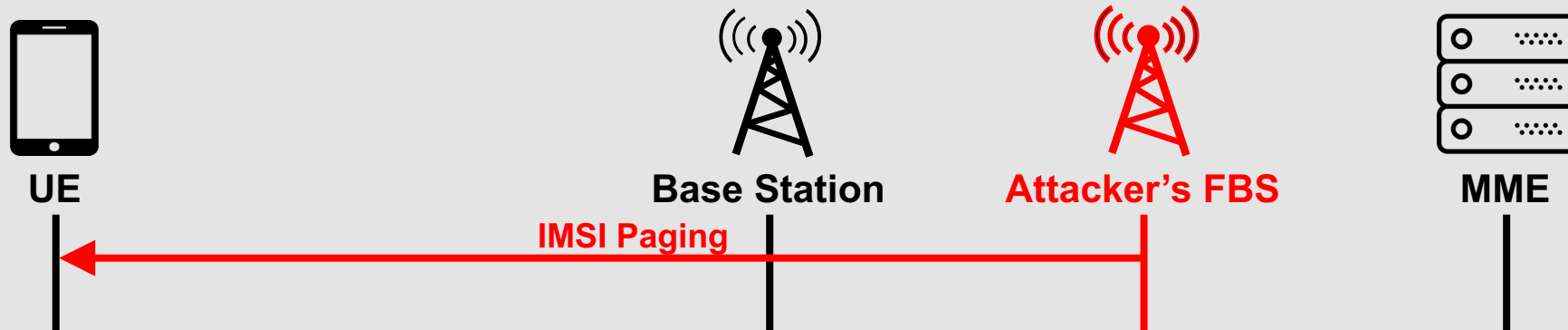

**3GPP 24.301 : UE immediately terminates all service sessions, deletes parameters including GUTI,  $KSI_{ASME}$  and initiates the registration procedure using the IMSI as the identifier on paging message.**

# SigOver + Alpha

- 2 : Victim performs the connection and registration process again

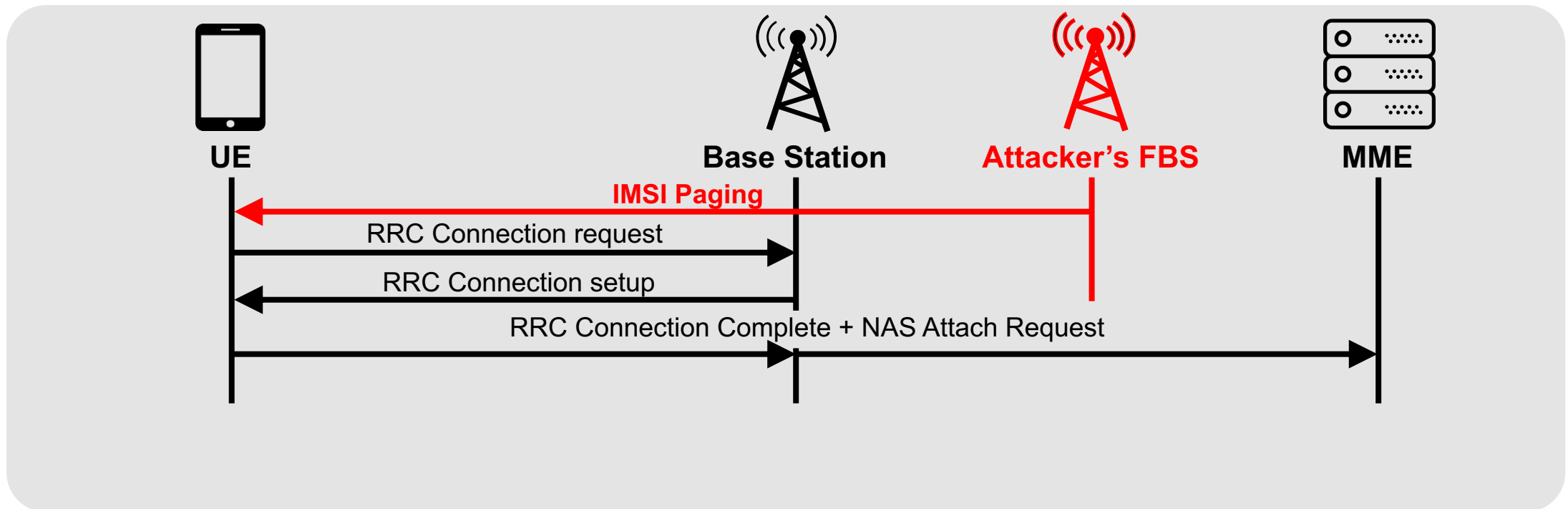



# SigOver + Alpha

- 3 : Before the victim and the network completes the security process, attacker injects a message

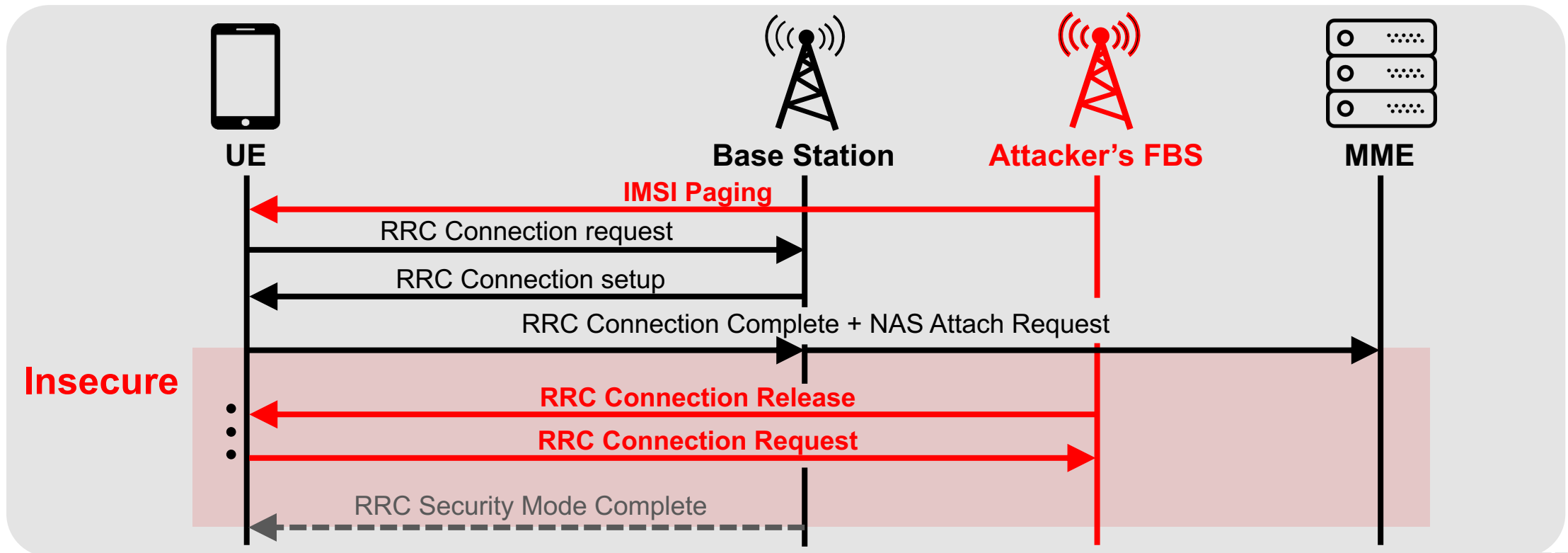

# AdaptOver w/ Service Reject

- Attacker assumption

- No key
- DL Sniffer
- Power >3dB

- Service Request

- UE with light usage: every 6 mins
- **EMM cause 8:** EPS services and non-EPS services not allowed

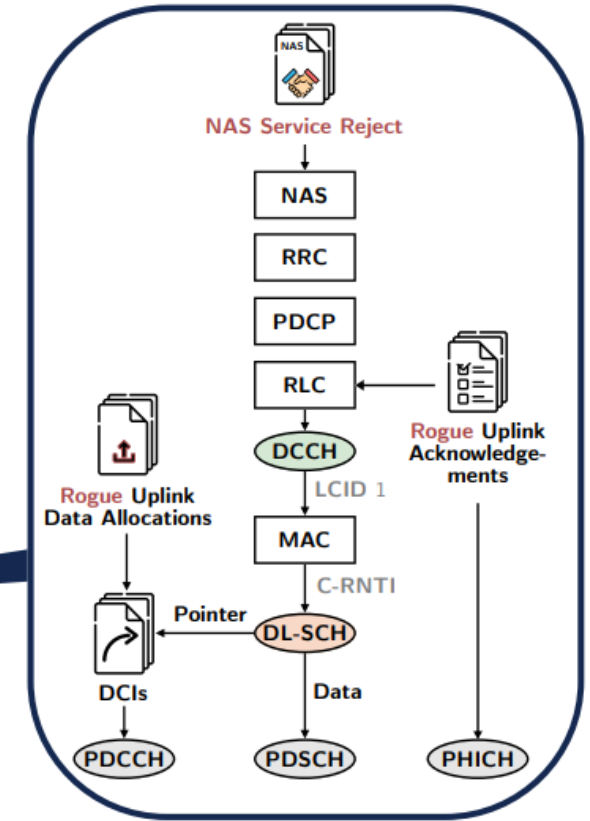
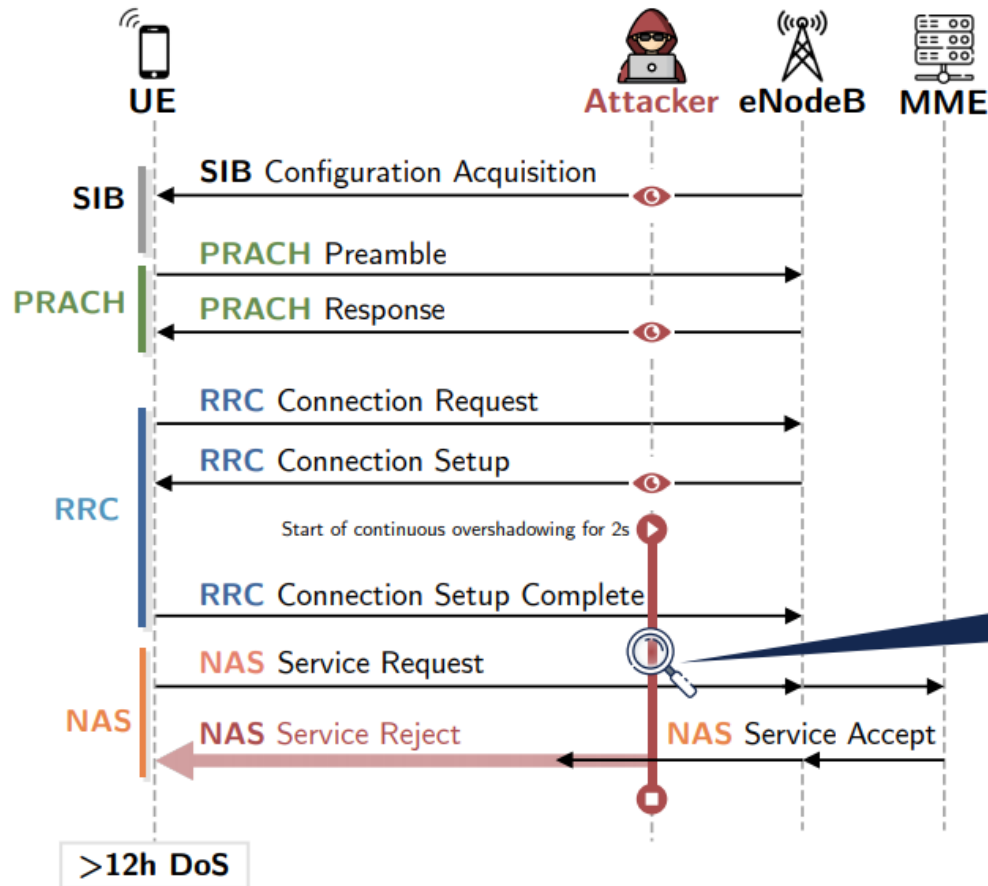

# AdaptOver w/ Service Reject in detail

- Service Reject with cause 8
  - UE considering the SIM card as invalid
  - Unless the user retries, the UE will back off by more than 12 h
- Attack timing
  - Upon receiving the **RRC Connection Setup**, it **continuously** inject Service Reject message on every subframe for **2 sec**
  - Experiment showed that 50ms also sufficed
- Challenge
  1. Too early injection : can overshadow uplink allocation for Service Request
  2. Injection must happen before the next DL message (at most before 8ms)
- Approach
  - Also inject uplink allocation and ACK
  - Achieve a latency of less than 6ms between receiving DL message and starting AdaptOver

# Implementation

- DL decoder
  - Listen PRACH Response message to acquire RNTI
  - Decode PDSCH messages (parameter, attack timing)
- Uplink allocation
  - Send uplink allocation at the subframe 0 of every frame
  - Send HARQ ACK at the subframe 8
- Sequence number of ACK
  - RLC : While messages are segmented, ACK must be sent for the highest seq number
  - MAC

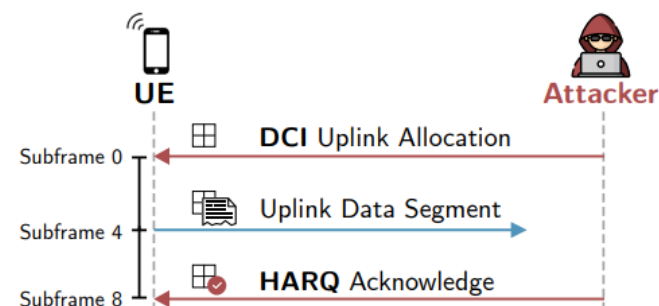
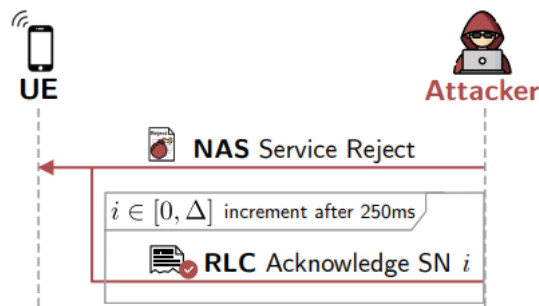

# EMM cause #8?

- Well, it was covered
  - LTE and IMSI catcher myths (2015, Altaf, BlackHat Europe)
  - Practical attacks against privacy and ~ (2016, Altaf, NDSS)
  - LTE security, protocol exploits and location~ (2016, Roger Piqueras Jover)

Cause #8 – EPS services and non-EPS services not allowed

This EMM cause is sent to the UE when it is not allowed to operate either EPS or non-EPS services.

## 5.6.1.5 Service request procedure not accepted by the network

The UE shall take the following actions depending on the received EMM cause value in the SERVICE REJECT message.

#3 (Illegal UE);

#6 (Illegal ME); or

#8 (EPS services and non-EPS services not allowed);

The UE shall set the EPS update status to EU3 ROAMING NOT ALLOWED (and shall store it according to subclause 5.1.3.3) and shall delete any GUTI, last visited registered TAI, TAI list and eKSI. The UE shall consider the USIM as invalid for EPS services until switching off or the UICC containing the USIM is removed or the timer T3245 expires as described in subclause 5.3.7a. The UE shall enter the state EMM-DEREGISTERED. If the message has been successfully integrity checked by the NAS and the UE maintains a counter for "SIM/USIM considered invalid for GPRS services", then the UE shall set this counter to UE implementation-specific maximum value.

If A/Gb mode or Iu mode is supported by the UE, the UE shall handle the GMM parameters GMM state, GPRS update status, P-TMSI, P-TMSI signature, RAI and GPRS ciphering key sequence number and the MM parameters update status, TMSI, LAI and ciphering key sequence number as specified in 3GPP TS 24.008 [13] for the case when the service request procedure is rejected with the GMM cause with the same value. The USIM shall be considered as invalid also for non-EPS services until switching off or the UICC containing the USIM is removed or the timer T3245 expires as described in subclause 5.3.7a. If the message has been successfully integrity checked by the NAS and the UE maintains a counter for "SIM/USIM considered invalid for non-GPRS services", then the UE shall set this counter to UE implementation-specific maximum value.

# Other Attacks Based on AdaptOver

- Authentication Reject Attack

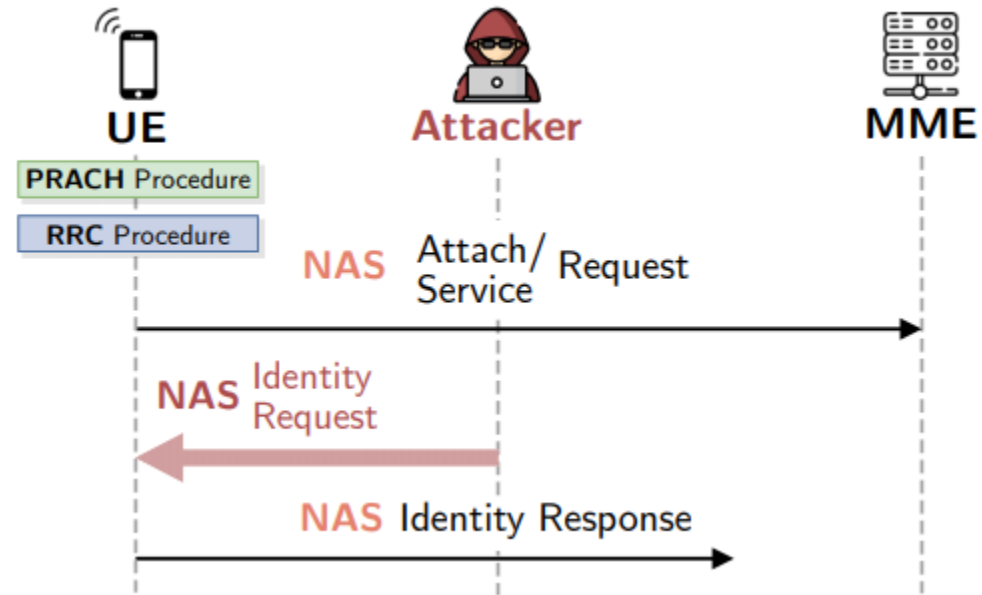
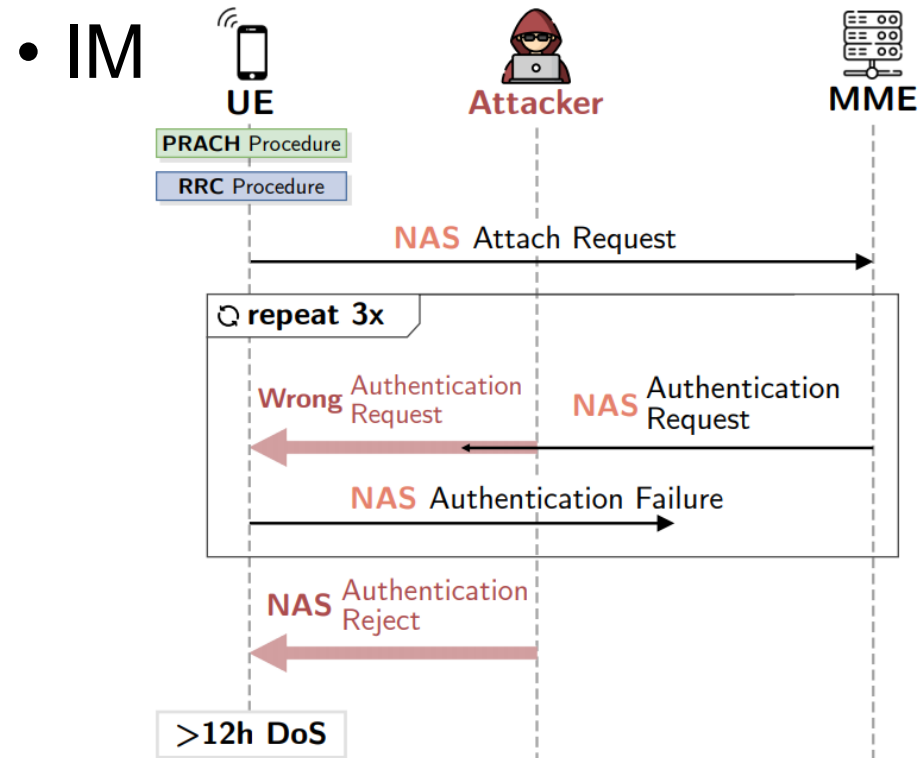

# Hardware Setup

- Laptop
- B210
- srsLTE
- Amarisoft Callbox

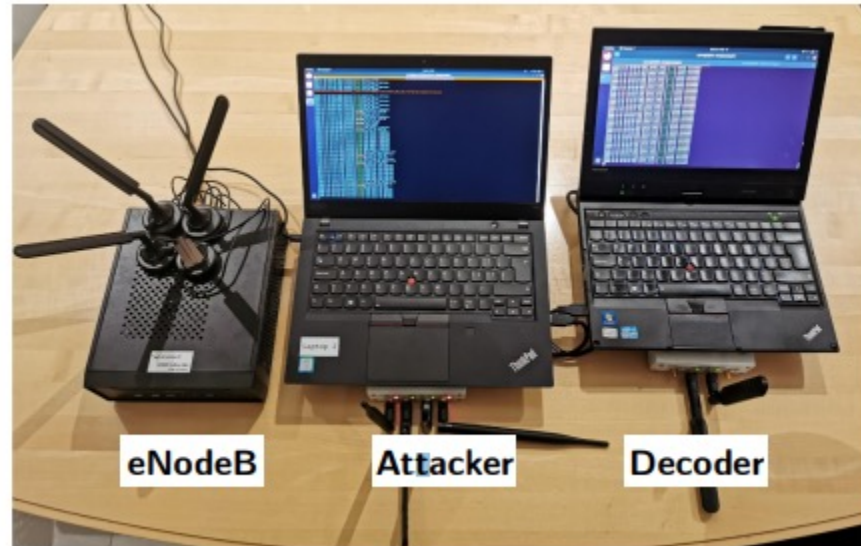

# Result

- DoS Attack

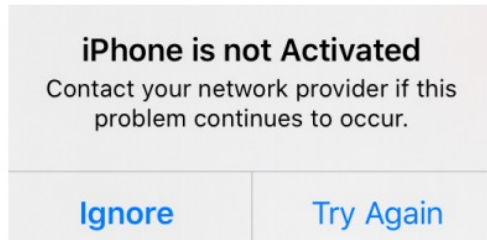

(a) iPhone 6S

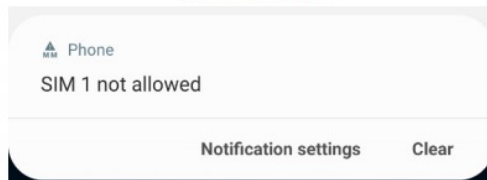

(b) Samsung Galaxy A8

Phone	Service Reject			Attach Reject			Authentication Reject		
	Duration <sup>1</sup>	Action <sup>2</sup>	GUI <sup>3</sup>	Duration <sup>1</sup>	Action <sup>2</sup>	GUI <sup>3</sup>	Duration <sup>1</sup>	Action <sup>2</sup>	GUI <sup>3</sup>
Pixel 2	>12h	R	<input type="checkbox"/>	> 12h	R	<input type="checkbox"/>	> 12h	R	<input type="checkbox"/>
Pixel 3a	>12h	T	<input type="checkbox"/>	> 12h	T	<input type="checkbox"/>	> 12h	T	<input type="checkbox"/>
Huawei P20 Pro	>12h	T	<input type="checkbox"/>	> 12h	T	<input type="checkbox"/>	> 12h	T	<input type="checkbox"/>
Huawei P30	>12h	T	■	> 12h	T	■	>12h	T	■
Huawei P30 Lite	>12h	T	<input type="checkbox"/>	> 12h	T	<input type="checkbox"/>	> 12h	T	<input type="checkbox"/>
Samsung Galaxy A8	>12h	T	■	> 12h	T	■	> 12h	T	<input type="checkbox"/>
Samsung Galaxy S10	>12h	T	■	> 12h	T	■	> 12h	T	<input type="checkbox"/>
LG Nexus 5X	>12h	S	■	> 12h	R	<input type="checkbox"/>	> 12h	R	<input type="checkbox"/>
iPhone 6S	>12h	R	■	> 12h	R	■	> 12h	R	■
iPhone 7	>12h	T	<input type="checkbox"/>	> 12h	T	<input type="checkbox"/>	> 12h	T	<input type="checkbox"/>
iPhone 8	>12h	T	<input type="checkbox"/>	> 12h	T	<input type="checkbox"/>	> 12h	T	<input type="checkbox"/>
iPhone 11	>12h	T	<input type="checkbox"/>	> 12h	T	<input type="checkbox"/>	> 12h	T	<input type="checkbox"/>
iPhone 11 Pro	>12h	T	<input type="checkbox"/>	> 12h	T	<input type="checkbox"/>	> 12h	T	<input type="checkbox"/>
iPhone X	9.78h	T	<input type="checkbox"/>	> 12h	T	<input type="checkbox"/>	> 12h	T	<input type="checkbox"/>
HTC U12+	>12h	T	<input type="checkbox"/>	> 12h	T	<input type="checkbox"/>	> 12h	T	<input type="checkbox"/>
OnePlus 7T Pro	>12h	T	<input type="checkbox"/>	> 12h	T	■	> 12h	T	<input type="checkbox"/>
Xiaomi Mi 9	>12h	T	<input type="checkbox"/>	> 12h	T	<input type="checkbox"/>	> 12h	T	<input type="checkbox"/>
Xiaomi Mi Mix 3 5G	>12h	T	<input type="checkbox"/>	> 12h	T	<input type="checkbox"/>	> 12h	T	<input type="checkbox"/>

<sup>1</sup> Duration until the UE re-established a connection by itself

<sup>2</sup> Action that will re-connect the phone immediately, **T**: Toggle flight mode, **R**: Restart phone, **S**: Reinsert SIM Card

<sup>3</sup> Whether an indicator on the GUI is present

Table 1: Attack Results for DoS Attack carried out by AdaptOver



# Power Requirement

- Assuming free space path loss and equal antenna gain,

- Power requirement:  $\left\{ 10^{\frac{3+20 \cdot \log_{10} \left( \frac{c}{a} \right)}{10}} * (P_{eNB}) \right\}$ 
  - Max TX power of USRP X310 : 1W
  - Power of COTS RF amp (ZVE-2W-272 amplifier) : 2W

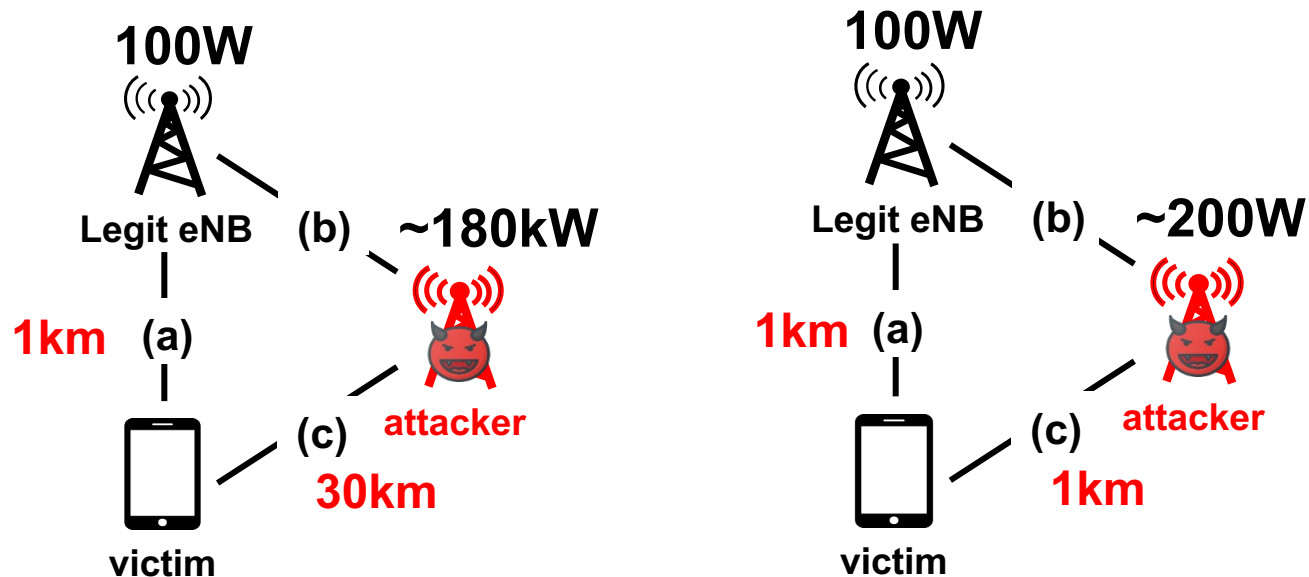

Assuming $P_{eNB} = 100W$	c	Attacker's Power
a = 0.262km (Lab)	0.019km	1W
	0.032km	3W
	0.05km	7.2W
	0.1km	30W
a=1km	0.5km	50W
	1km	200W
	1.5km	450W
	30km	180000W
a=1.5km	0.5km	22W
	1km	88W
	1.5km	200W
	30km	80000W

# Power & Distance Requirement

- Power advantage
  - 1.8dB is sufficient
- Distance
  - Assuming 40dBm eNB and 20dBm attacker

$$d_{Attacker} \leq d_{\leftrightarrow} \cdot 10^{\left(\frac{P_{Attacker} - P_{eNodeB} - 3dB}{20}\right)}$$

$\mu_{J/S}$	$\sigma_{J/S}$	Success Rate
-2.049 dB	0.627	0%
-1.1202 dB	0.675	1.325%
-0.117 dB	0.665	30.625%
0.639 dB	0.619	96.825%
1.870 dB	0.641	100%
2.559 dB	0.733	100%

Table 2: Summary of Overshadowing Success Rate and Resulting J/S

$d_{\leftrightarrow}$	Downlink max $d_{Attacker}$
100m	7.1m
500m	35.4m
1km	70.8m

Table 3: Estimated Attack Range for an attacker transmit power of 20dB. The basestation emits its downlink signal with a power of 40dB.  $d_{\leftrightarrow}$  denotes distance between UE and basestation. max  $d_{Attacker}$  is the distance between attacker and victim UE.